

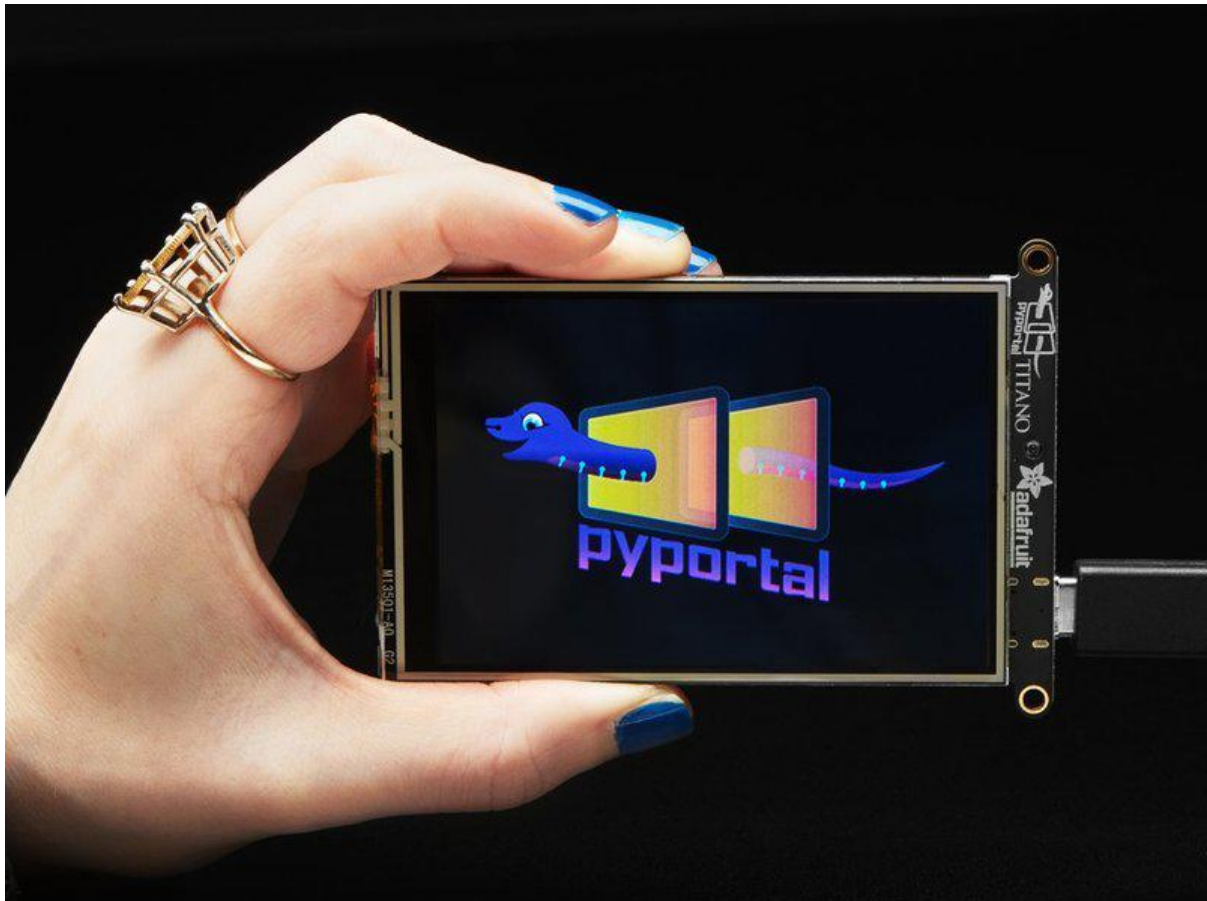

Adafruit PyPortal Titano

Created by Kattni Rembor



<https://learn.adafruit.com/adafruit-pyportal-titano>

Last updated on 2022-07-20 02:05:47 PM EDT

Table of Contents

Overview	7
Pinouts	10
<ul style="list-style-type: none">• Microcontroller and Flash• WiFi• Display and Display Connector• Light Sensor• microSD Card Slot• Speaker and Speaker Connector• I2C Connector• Digital/Analog Connectors• Status LED and NeoPixel• USB Connector• Reset Button	
What is CircuitPython?	17
<ul style="list-style-type: none">• CircuitPython is based on Python• Why would I use CircuitPython?	
CircuitPython	19
<ul style="list-style-type: none">• Set up CircuitPython Quick Start!• PyPortal Titano Default Files	
Installing the Mu Editor	22
<ul style="list-style-type: none">• Download and Install Mu• Starting Up Mu• Using Mu	
Creating and Editing Code	24
<ul style="list-style-type: none">• Creating Code• Editing Code• Back to Editing Code...• Naming Your Program File	
Connecting to the Serial Console	29
<ul style="list-style-type: none">• Are you using Mu?• Serial Console Issues or Delays on Linux• Setting Permissions on Linux• Using Something Else?	
Interacting with the Serial Console	32
The REPL	35
<ul style="list-style-type: none">• Entering the REPL• Interacting with the REPL• Returning to the Serial Console	
CircuitPython Libraries	40
<ul style="list-style-type: none">• The Adafruit Learn Guide Project Bundle• The Adafruit CircuitPython Library Bundle• Downloading the Adafruit CircuitPython Library Bundle	

- [The CircuitPython Community Library Bundle](#)
- [Downloading the CircuitPython Community Library Bundle](#)
- [Understanding the Bundle](#)
- [Example Files](#)
- [Copying Libraries to Your Board](#)
- [Understanding Which Libraries to Install](#)
- [Example: ImportError Due to Missing Library](#)
- [Library Install on Non-Express Boards](#)
- [Updating CircuitPython Libraries and Examples](#)
- [CircUp CLI Tool](#)

CircuitPython Pins and Modules

51

- [CircuitPython Pins](#)
- [import board](#)
- [I2C, SPI, and UART](#)
- [What Are All the Available Names?](#)
- [Microcontroller Pin Names](#)
- [CircuitPython Built-In Modules](#)

Frequently Asked Questions

56

Troubleshooting

60

- [Always Run the Latest Version of CircuitPython and Libraries](#)
- [I have to continue using CircuitPython 5.x or earlier. Where can I find compatible libraries?](#)
- [Bootloader \(boardnameBOOT\) Drive Not Present](#)
- [Windows Explorer Locks Up When Accessing boardnameBOOT Drive](#)
- [Copying UF2 to boardnameBOOT Drive Hangs at 0% Copied](#)
- [CIRCUITPY Drive Does Not Appear or Disappears Quickly](#)
- [Device Errors or Problems on Windows](#)
- [Serial Console in Mu Not Displaying Anything](#)
- [code.py Restarts Constantly](#)
- [CircuitPython RGB Status Light](#)
- [CircuitPython 7.0.0 and Later](#)
- [CircuitPython 6.3.0 and earlier](#)
- [Serial console showing ValueError: Incompatible .mpy file](#)
- [CIRCUITPY Drive Issues](#)
- [Safe Mode](#)
- [To erase CIRCUITPY: storage.erase_filesystem\(\)](#)
- [Erase CIRCUITPY Without Access to the REPL](#)
- [For the specific boards listed below:](#)
- [For SAMD21 non-Express boards that have a UF2 bootloader:](#)
- [For SAMD21 non-Express boards that do not have a UF2 bootloader:](#)
- [Running Out of File Space on SAMD21 Non-Express Boards](#)
- [Delete something!](#)
- [Use tabs](#)
- [On MacOS?](#)
- [Prevent & Remove MacOS Hidden Files](#)
- [Copy Files on MacOS Without Creating Hidden Files](#)
- [Other MacOS Space-Saving Tips](#)
- [Device Locked Up or Boot Looping](#)

"Uninstalling" CircuitPython

78

- [Backup Your Code](#)
- [Moving Circuit Playground Express to MakeCode](#)
- [Moving to Arduino](#)

Welcome to the Community!	81
<ul style="list-style-type: none">• Adafruit Discord• CircuitPython.org• Adafruit GitHub• Adafruit Forums• Read the Docs	
PyPortal CircuitPython Setup	90
<ul style="list-style-type: none">• Adafruit CircuitPython Bundle	
Internet Connect!	92
<ul style="list-style-type: none">• What's a secrets file?• Connect to WiFi• Requests• HTTP GET with Requests• HTTP POST with Requests• Advanced Requests Usage• WiFi Manager	
Arduino IDE Setup	104
Using with Arduino IDE	107
<ul style="list-style-type: none">• Install SAMD Support• Install Adafruit SAMD• Install Drivers (Windows 7 & 8 Only)• Blink• Successful Upload• Compilation Issues• Manually bootloading• Ubuntu & Linux Issue Fix	
Arduino Libraries	114
<ul style="list-style-type: none">• Install Libraries• Adafruit NeoPixel• Adafruit SPIFlash• Adafruit Zero DMA• Adafruit GFX• Adafruit ILI9341• Adafruit HX8357• Adafruit Touchscreen• Analog Devices ADT7410• WiFiNINA• Adafruit ImageReader	
Arduino Test	117
Updating ESP32 Firmware	122
Parsing JSON	122
<ul style="list-style-type: none">• Parsing JSON from the Web• Parsing local JSON files	
PyPortal Hardware FAQ	125

- Files
- Schematic and Fab Print

Overview



The PyPortal Titano is the big sister to our [popular PyPortal](https://adafru.it/pyportal) (https://adafru.it/pyportal) now with twice as many pixels! The PyPortal is our easy-to-use IoT device that allows you to create all the things for the “Internet of Things” in minutes. Make custom touch screen interface GUIs, all open-source, and Python-powered using tinyJSON / APIs to get news, stock, weather, cat photos, and more – all over WiFi with the latest technologies. Create little pocket universes of joy that connect to something good. Rotate it 90 degrees, it’s a web-connected conference badge #badgelif.

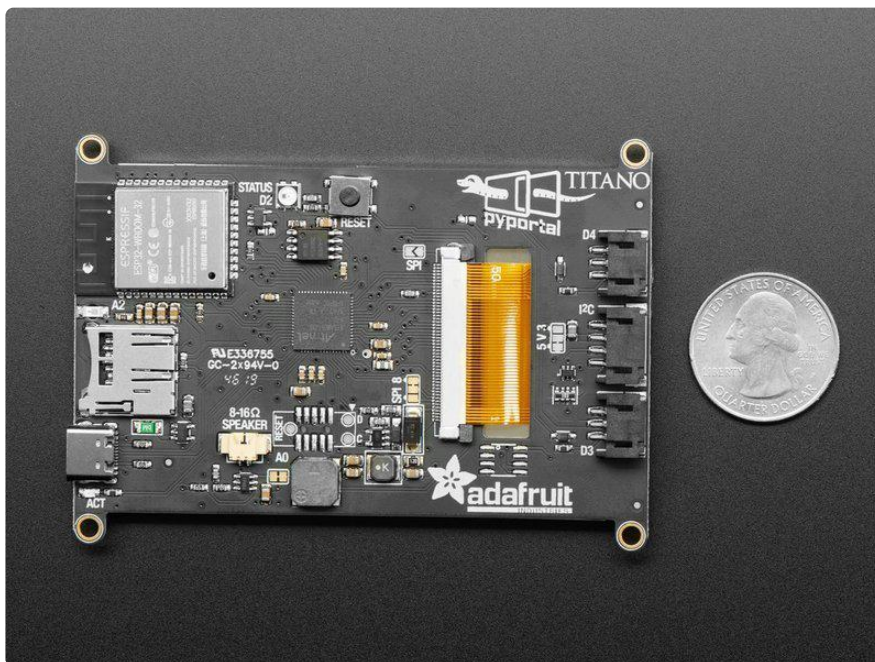

The Titano uses an ATMEL (Microchip) ATSAM51J20, and an Espressif ESP32 Wi-Fi coprocessor with TLS/SSL support built-in. Titano has a bigger 3.5" diagonal 320 x 480 color TFT with resistive touch screen. Compare that to the original PyPortal's 3.2" 240x320, we have twice as many pixels! Also, we've updated the connector to be a reverse-friendly USB C connector.

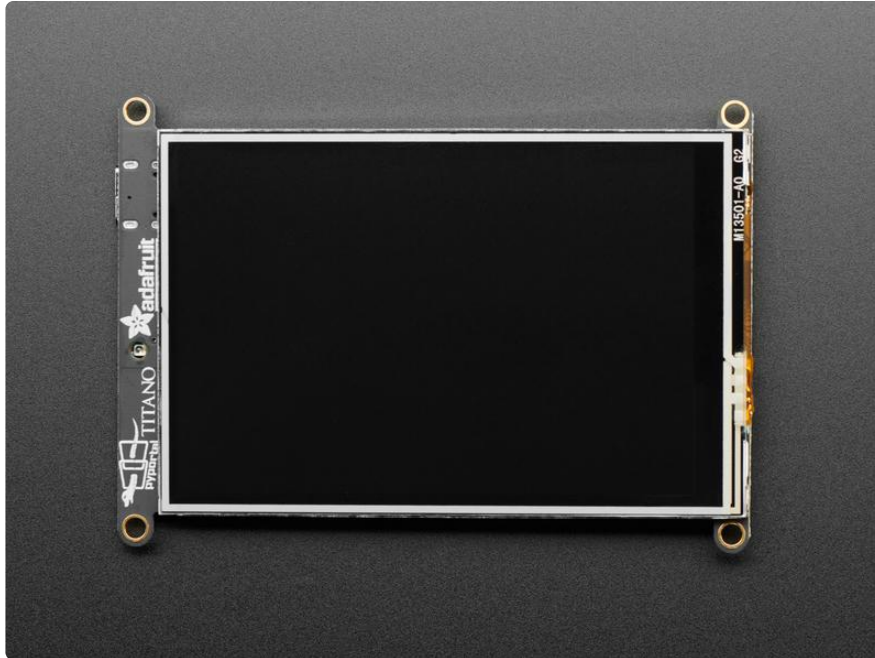

Compared to the original PyPortal, the Titano does not include a ADT7410 temperature sensor. It also has a higher-resolution screen with a different controller chip. The processor, STEMMA connectors and WiFi have the exact same wiring as the original 3.2" PyPortal so if you are running Arduino or CircuitPython code, you'll need to adjust your graphics and fonts for the larger resolution screen!



The PyPortal Titano includes: a speaker, light sensor, NeoPixel, microSD card slot, 8MB flash, plug-in ports for I2C and 2 analog/digital pins. Open-source hardware, and Open-Source software, and works with CircuitPython and Arduino. The device shows up as a USB drive and CircuitPython code can be edited in any IDE, text editor, etc.



The M4 and ESP32 are a great couple - and each bring their own strengths to this board. The SAMD51 M4 has native USB, so it can show up like a disk drive, act as a MIDI or HID keyboard/mouse, and of course bootload and debug over a serial port. It also has DACs, ADC, PWM, and tons of GPIO. Meanwhile, the ESP32 has secure WiFi capabilities, and plenty of Flash and RAM to buffer sockets. By letting the ESP32 focus on the complex TLS/SSL computation and socket buffering, it frees up the SAMD51 to act as the user interface. You get a great programming experience thanks to the native USB with files available for drag-n-drop, and you don't have to spend a ton of processor time and memory to do SSL encryption/decryption and certificate management. It's the best of both worlds!

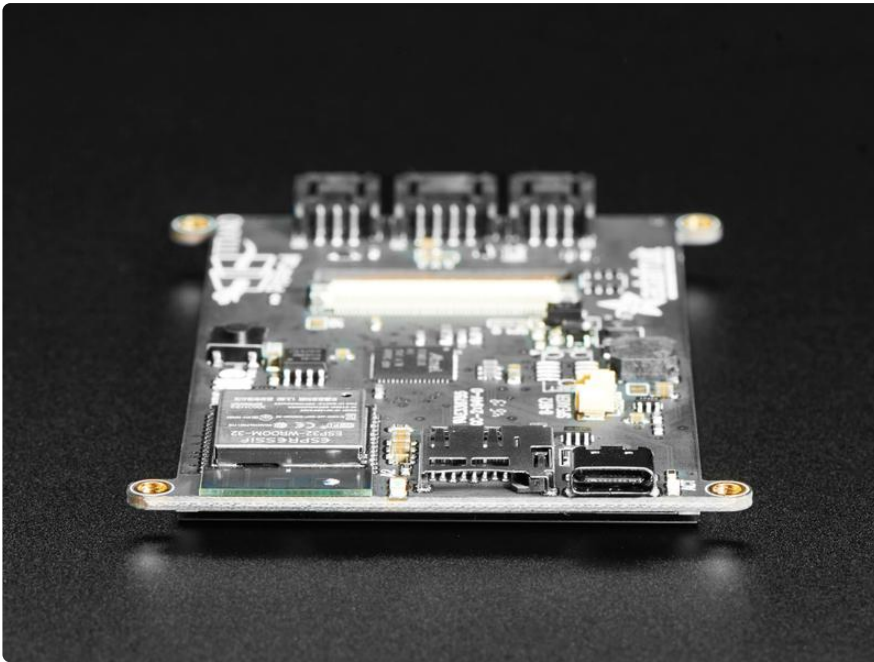

Pinouts

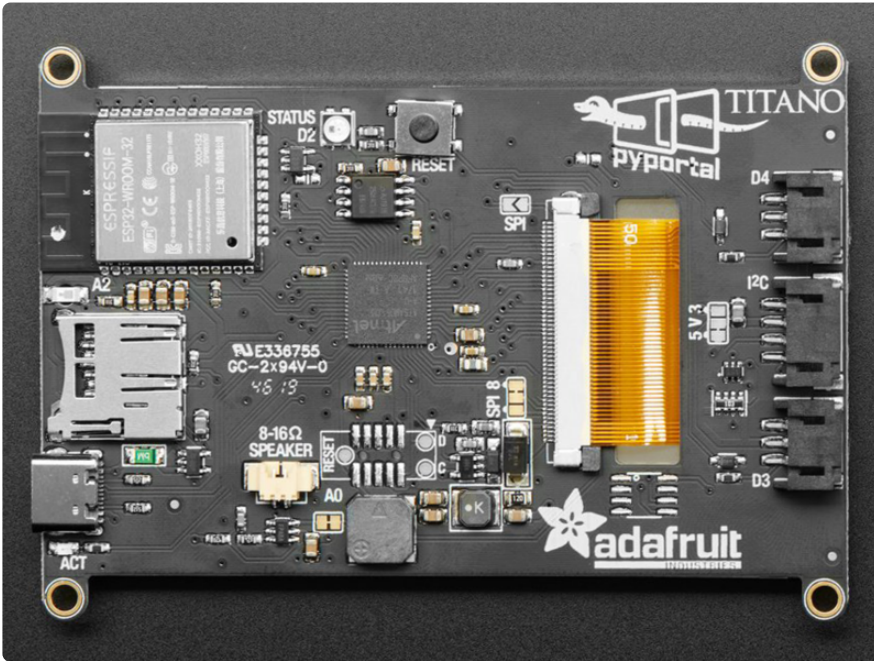

ESP32 WiFi Co-processor Control

ESP_CS	PA4	04.0	04.0	TC0(1)	GPIO23	GPIO23	DATA7
ESP_SCLK	PA10	04.0	04.0	TC0(2)	GPIO19	GPIO19	DATA6
ESP_MISO	PA9	04.0	04.0	TC0(3)	GPIO18	GPIO18	DATA5
ESP_MOSI	PA8	04.0	04.0	TC0(4)	GPIO17	GPIO17	DATA4
ESP_RST	PA5	04.0	04.0	TC0(5)	GPIO16	GPIO16	DATA3
ESP_VCC	PA0	04.0	04.0	TC0(6)	GPIO15	GPIO15	DATA2
ESP_GND	PA1	04.0	04.0	TC0(7)	GPIO14	GPIO14	DATA1
MRST	PA22	04.0	04.0	TC1(0)	GPIO28	GPIO28	SEN1
RST	PA21	04.0	04.0	TC1(1)	GPIO27	GPIO27	SEN2
KEY	PA23	04.0	04.0	TC1(2)	GPIO29	GPIO29	CLK

LCD Screen Data Pins

LED_DATA7	PA14	04.0	04.0	TC2(1)	GPIO20	GPIO20	DATA7
LED_DATA6	PA13	04.0	04.0	TC2(2)	GPIO19	GPIO19	DATA6
LED_DATA5	PA12	04.0	04.0	TC2(3)	GPIO18	GPIO18	DATA5
LED_DATA4	PA11	04.0	04.0	TC2(4)	GPIO17	GPIO17	DATA4
LED_DATA3	PA10	04.0	04.0	TC2(5)	GPIO16	GPIO16	DATA3
LED_DATA2	PA9	04.0	04.0	TC2(6)	GPIO15	GPIO15	DATA2
LED_DATA1	PA8	04.0	04.0	TC2(7)	GPIO14	GPIO14	DATA1
LED_VCC	PA0	04.0	04.0	TC2(8)	GPIO15	GPIO15	DATA2
LED_GND	PA1	04.0	04.0	TC2(9)	GPIO14	GPIO14	DATA1
TFT_RST	PA15	04.0	04.0	TC3(0)	GPIO21	GPIO21	SEN1
TFT_BLK/INT	PA16	04.0	04.0	TC3(1)	GPIO22	GPIO22	SEN2

TFT Screen Control

TFT_RESET	PA00	04.0	04.0	TC1(3)	GPIO24	GPIO24	
TFT_M0	PA01	04.0	04.0	A1(0)	GPIO25	GPIO25	
TFT_M1	PA02	04.0	04.0	A1(1)	GPIO26	GPIO26	
TFT_M2	PA03	04.0	04.0	A1(2)	GPIO27	GPIO27	
TFT_M3	PA04	04.0	04.0	A1(3)	GPIO28	GPIO28	
TFT_M4	PA05	04.0	04.0	A1(4)	GPIO29	GPIO29	
TFT_M5	PA06	04.0	04.0	A1(5)	GPIO30	GPIO30	
TFT_M6	PA07	04.0	04.0	A1(6)	GPIO31	GPIO31	
TFT_M7	PA08	04.0	04.0	A1(7)	GPIO32	GPIO32	

Touchscreen Module Control

TRUCK_YH	EA03	04.0	04.0	AI(1)	GPIO43	GPIO43	
TRUCK_XL	EA04	04.0	04.0	AI(2)	GPIO44	GPIO44	
TRUCK_YL	EA05	04.0	04.0	AI(3)	GPIO45	GPIO45	
TRUCK_XR	EA06	04.0	04.0	AI(4)	GPIO46	GPIO46	

SD Card Module Control

SD_CS	PA10	04.0	04.0	TC2(5)	GPIO16	GPIO16	DATA3
SD_CMD	PA9	04.0	04.0	TC2(4)	GPIO15	GPIO15	DATA2
SD_MISO	PA8	04.0	04.0	TC2(3)	GPIO14	GPIO14	DATA1
SD_MOSI	PA7	04.0	04.0	TC2(2)	GPIO13	GPIO13	DATA0
SD_VCC	PA0	04.0	04.0	TC2(8)	GPIO15	GPIO15	DATA2
SD_GND	PA1	04.0	04.0	TC2(9)	GPIO14	GPIO14	DATA1

Speaker Control

SPK_A	PA2	04.0	04.0	TC2(1)	GPIO16	GPIO16	DATA3
SPK_B	PA3	04.0	04.0	TC2(2)	GPIO17	GPIO17	DATA4
SPK_ENABLE	PA7	04.0	04.0	TC2(3)	GPIO14	GPIO14	DATA1

Adafruit PyPortal Titano
<https://www.adafruit.com/product/4444>

Light Sensor Control

LIGHT	EA02	04.0	04.0	A1(0)	GPIO42	GPIO42	
-------	------	------	------	-------	--------	--------	--

[Click here to view a PDF version of the pinout diagram \(https://adafru.it/-dW\)](https://adafru.it/-dW)

There are so many great features on the Adafruit PyPortal Titano. Let's take a look at what's available!

Microcontroller and Flash

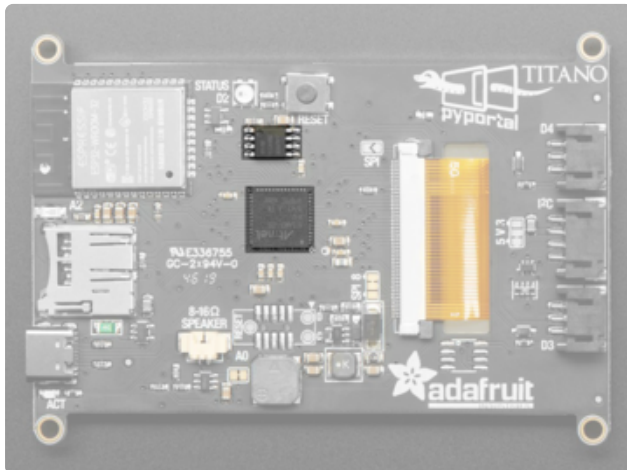

The main processor chip is the ATSAM51J20 Cortex M4 running at 120MHz with 3.3v logic/power. It has 1MB of Flash and 256KB of RAM.

We also include 8 MB of QSPI Flash for storing images, sounds, animations, whatever!

WiFi

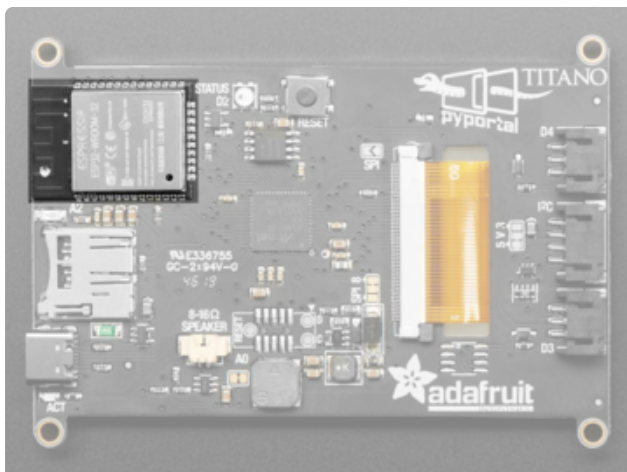

The WiFi capability uses an Espressif ESP32 Wi-Fi coprocessor with TLS/SSL support built-in.

The ESP32 uses the SPI port for data, and also uses a CS pin (`board.ESP_CS` or Arduino `8`), Ready/Busy pin (`board.ESP_BUSY` or Arduino `5`), and reset pin (`board.ESP_RESET` or Arduino `7`)

- For advanced use or reprogramming, we also connect the main RX/TX UART to the ESP32 - on Arduino that's `Serial1` and in CircuitPython use `board.RX` and `board.TX`.
- You can also connect to the ESP32 RTS pin (used in some serial contexts) on `board.ESP_RTS` or Arduino `51`.
- The ESP32 GPIO0 pin for bootloader enable is connected to `board.ESP_GPI00` or Arduino `6`

Display and Display Connector



On the front is a 3.5" diagonal 320 x 480 color TFT with resistive touch screen! The display uses the HX8357 chipset - [check out the datasheet \(https://adafru.it/dQQ\)](https://adafru.it/dQQ) for more information.

On the back, there is a large connector near the middle, the display connector. It connects the display on the front to the board.

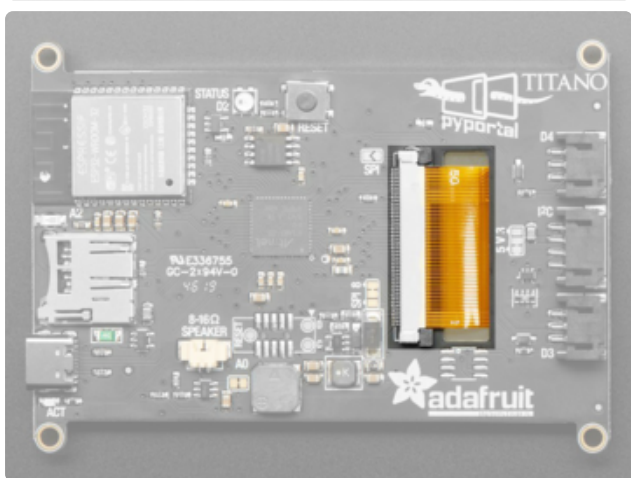

To give you the most data throughput, we configure the screen for 8-bit interfacing. That means 8 data lines and a collection of 4 or 5 control lines. If you really want to use the screen in SPI mode, you can do so by soldering closed the SPI jumper and cutting/resoldering the 8/SPI jumper over to the SPI side. That's for advanced users!

The touchscreen is fully analog/resistive. It can be read using our Arduino/CircuitPython drivers. The connections are as follows:

- YD on `board.TOUCH_YD` or Arduino `A4`
- XL on `board.TOUCH_XL` or Arduino `A5`
- YU on `board.TOUCH_YU` or Arduino `A6`
- XR on `board.TOUCH_XR` or Arduino `A7`

The 8 bit LCD interface is not exposed in CircuitPython (its managed internally). In Arduino it's on Digital 34 thru 41, which is on a PORTA 8-bit boundary (PA16-PA23) and can be used for DMA or fast port writes. This probably doesn't affect you.

There are multiple control pins

- TFT Reset - `board.TFT_RESET` or Arduino `24`

- TFT WR - `board.TFT_WR` or Arduino `26` (this is also the `board.TFT_DC` pin if using in SPI mode)
- TFT RD - `board.TFT_RD` or Arduino `9`
- TFT RS - `board.TFT_RS` or Arduino `10`
- TFT CS - `board.TFT_CS` or Arduino `11`
- TFT TE - `board.TFT_TE` or Arduino `12`

There is also a TFT backlight, transistor-connected to `board.TFT_BACKLIGHT` or Arduino `25`. You can PWM control it. There are 6 white LEDs connected in parallel, so having it be full on will draw quite a bit of current (over 100mA!)

Light Sensor

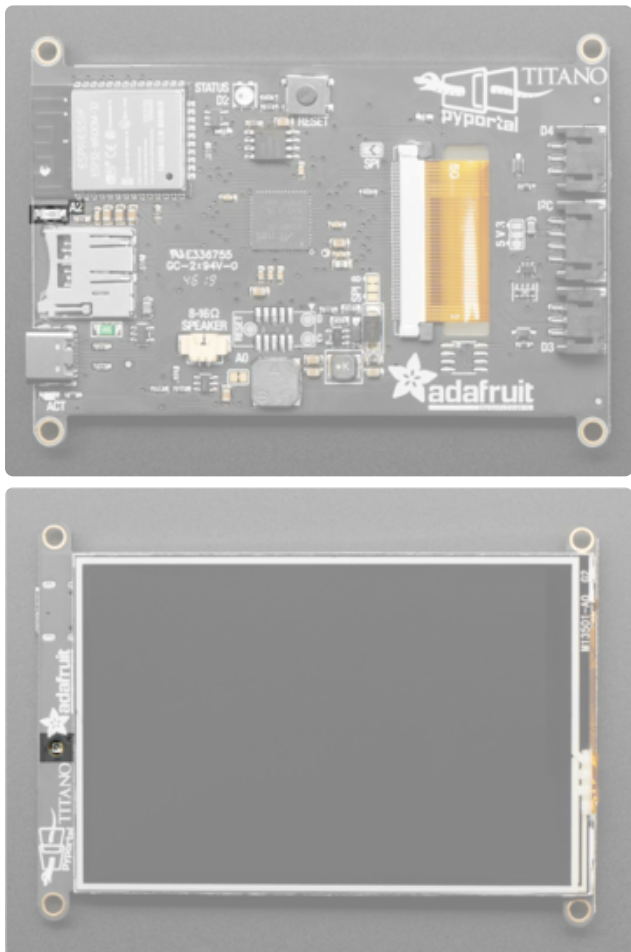

There is an ambient light sensor on the side, which points through to the front, as seen in the second image. The light sensor is an analog input, connected to `board.LIGHT` (CircuitPython) or `A2` (Arduino) you can read it as any analog value ranging from `0` (dark) to `1023` (in Arduino) or `65535` (CircuitPython) when bright.

microSD Card Slot

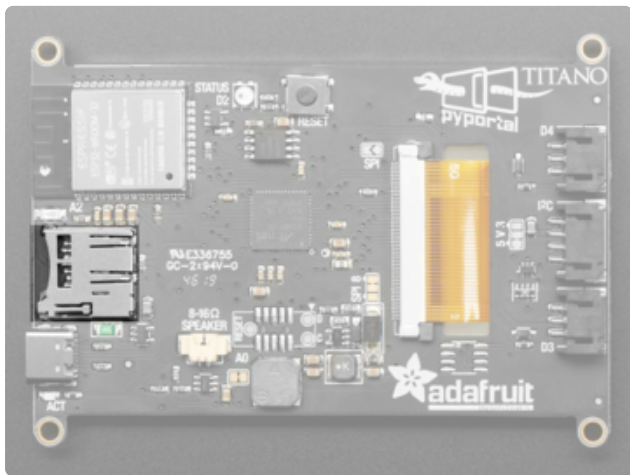

On the left side, there is a microSD card slot. A microSD card is the best way to add extra storage to your project and provide space for streams to be processed!

The SD card is on the main SPI port (shared with the ESP32) and a CS line. In CircuitPython, the CS pin is `board.SD_CS`. In Arduino, it's digital `32`.

There is also a card detect pin on `board.SD_CARD_DETECT` (CircuitPython) or Arduino `33`.

Speaker and Speaker Connector

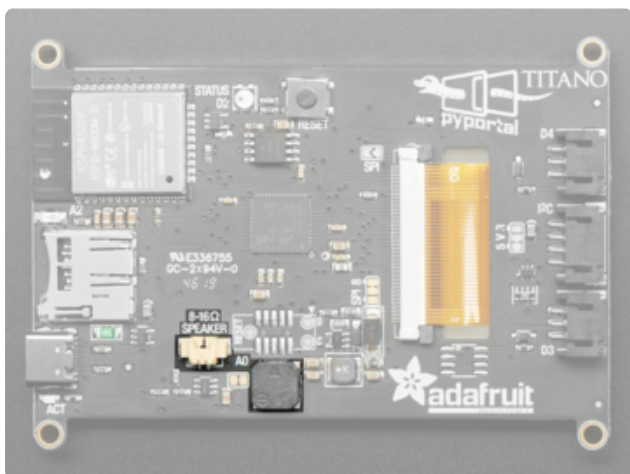

There is a speaker and a speaker connector.

The grey squarish bit on the bottom is a speaker. There is a small class D amplifier connected to the speaker, so it can get quite loud!

There is also a speaker connector, which is a [Molex PicoBlade \(https://adafru.it/C8p\)](https://adafru.it/C8p). You can attach one of the speakers available in the Adafruit shop, or solder a connector to your favorite speaker. If you do, cut the small solder jumper to the left of the buzzer so that you only have one speaker activated (and also it will be louder!)

The speaker is connected to the DAC0 output from the SAMD51, via a class D amplifier. The analog output is known as `board.AUDIO_OUT` in CircuitPython. In Arduino its `A0`.

You can disable the speaker amplifier by setting the shutdown pin to output and low. It's on `board.SPEAKER_ENABLE` and Arduino [50](#)

I2C Connector

Unlike the original PyPortal, the I2C connector is level shifted to 3V so its safe to use without changing the power trace

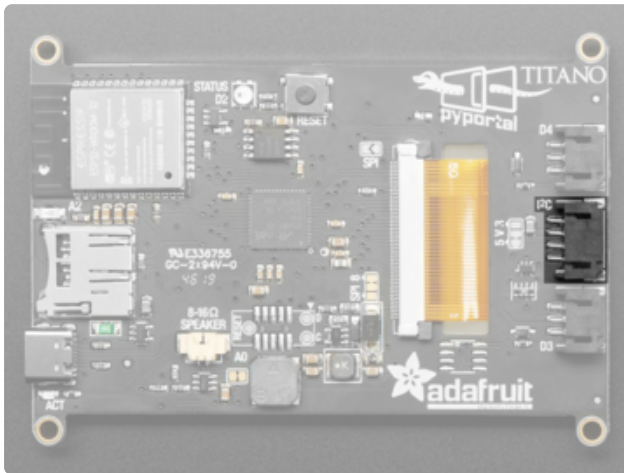

There is a 4-pin JST I2C connector in the center on the right, that is STEMMA and Grove compatible. The I2C has level-shifting & pullups to 3.3V power.

The I2C connector defaults to 5V. There is a jumper you can cut or solder to change it between 5V and 3V.

In CircuitPython, you can use the STEMMA connector with `board.SCL` and `board.SDA`, or `board.STEMMA_I2C()`.

The connector is a JST PH-sized connector. STEMMA QT breakouts use JST SH connectors, which are smaller, so you will need a JST PH to SH connector (for example, [this one \(https://adafru.it/IDk\)](https://adafru.it/IDk)).

Digital/Analog Connectors

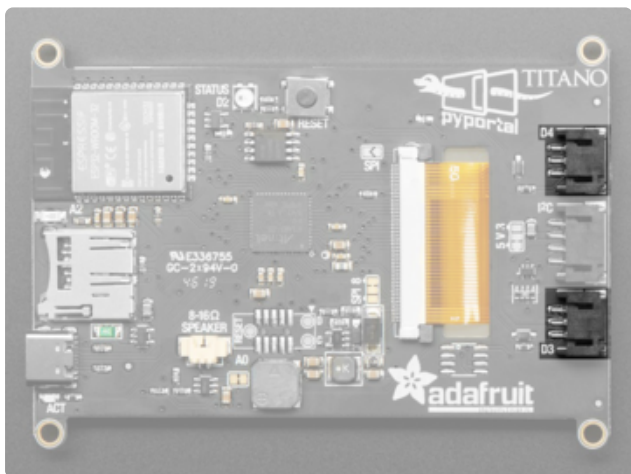

On the right side are two connectors labeled D3 and D4. These are 3-pin JST digital or analog connectors for sensors or NeoPixels. These pins can be analog inputs or digital I/O.

They have protection 1K resistors + 3.6V zener diodes so you can drive an LED directly from the output. Connect to them via `board.D3` and `board.D4` or Arduino `3` and `4`. For analog reading in Arduino use A1 for D3 and A3 for D4 (yeah, sorry it's not matchy!)

D3/A1 is the second DAC.

Status LED and NeoPixel

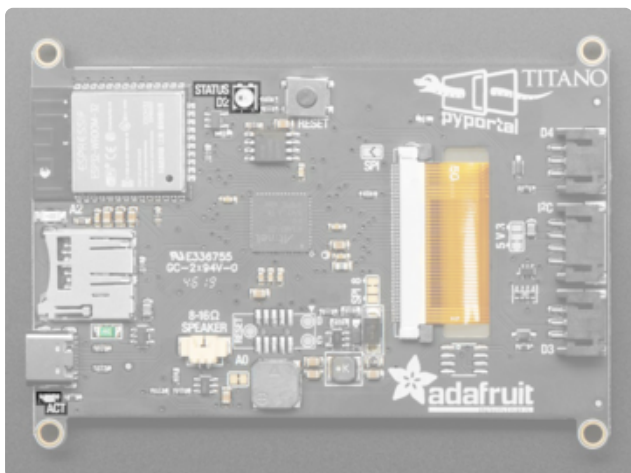

There are two LEDs on the board.

There is the RGB status NeoPixel labeled "STATUS". It is connected to `board.NEOPIXEL` or Arduino `2`

As well, there is the D13 LED. This is attached to `board.L` and Arduino `13`

USB Connector

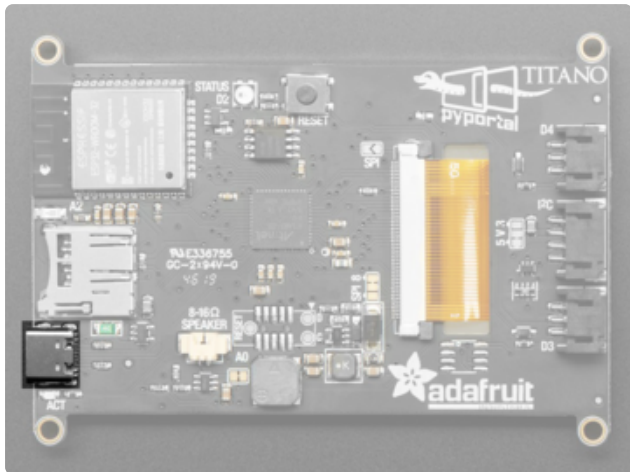

There is one USB port on the board.

On the left side, towards the bottom, is a USB Type-C port, which is used for powering and programming the board.

Reset Button

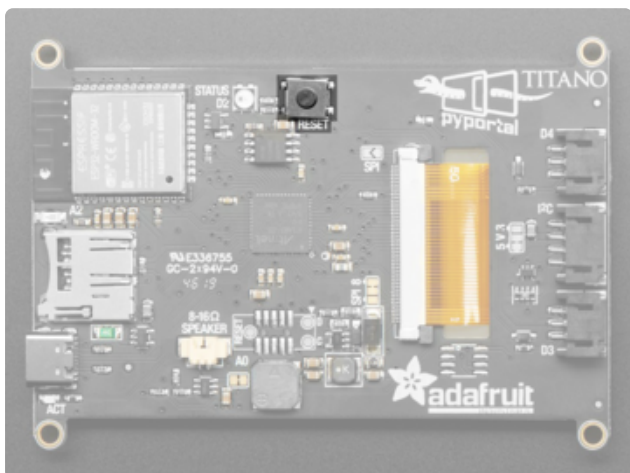

The reset button is located on the top in the middle.

Click it once to re-start your firmware.
Click twice to enter bootloader mode.

What is CircuitPython?

CircuitPython is a programming language designed to simplify experimenting and learning to program on low-cost microcontroller boards. It makes getting started easier than ever with no upfront desktop downloads needed. Once you get your board set up, open any text editor, and get started editing code. It's that simple.



CircuitPython is based on Python

Python is the fastest growing programming language. It's taught in schools and universities. It's a high-level programming language which means it's designed to be easier to read, write and maintain. It supports modules and packages which means it's easy to reuse your code for other projects. It has a built in interpreter which means there are no extra steps, like compiling, to get your code to work. And of course, Python is Open Source Software which means it's free for anyone to use, modify or improve upon.

CircuitPython adds hardware support to all of these amazing features. If you already have Python knowledge, you can easily apply that to using CircuitPython. If you have no previous experience, it's really simple to get started!



Why would I use CircuitPython?

CircuitPython is designed to run on microcontroller boards. A microcontroller board is a board with a microcontroller chip that's essentially an itty-bitty all-in-one computer. The board you're holding is a microcontroller board! CircuitPython is easy to use because all you need is that little board, a USB cable, and a computer with a USB connection. But that's only the beginning.

Other reasons to use CircuitPython include:

- You want to get up and running quickly. Create a file, edit your code, save the file, and it runs immediately. There is no compiling, no downloading and no uploading needed.
- You're new to programming. CircuitPython is designed with education in mind. It's easy to start learning how to program and you get immediate feedback from the board.

- Easily update your code. Since your code lives on the disk drive, you can edit it whenever you like, you can also keep multiple files around for easy experimentation.
- The serial console and REPL. These allow for live feedback from your code and interactive programming.
- File storage. The internal storage for CircuitPython makes it great for data-logging, playing audio clips, and otherwise interacting with files.
- Strong hardware support. There are many libraries and drivers for sensors, breakout boards and other external components.
- It's Python! Python is the fastest-growing programming language. It's taught in schools and universities. CircuitPython is almost-completely compatible with Python. It simply adds hardware support.

This is just the beginning. CircuitPython continues to evolve, and is constantly being updated. Adafruit welcomes and encourages feedback from the community, and incorporate it into the development of CircuitPython. That's the core of the open source concept. This makes CircuitPython better for you and everyone who uses it!

CircuitPython

[CircuitPython \(https://adafru.it/tB7\)](https://adafru.it/tB7) is a derivative of [MicroPython \(https://adafru.it/BeZ\)](https://adafru.it/BeZ) designed to simplify experimentation and education on low-cost microcontrollers. It makes it easier than ever to get prototyping by requiring no upfront desktop software downloads. Simply copy and edit files on the CIRCUITPY "flash" drive to iterate.

The following instructions will show you how to install CircuitPython. If you've already installed CircuitPython but are looking to update it or reinstall it, the same steps work for that as well!

Set up CircuitPython Quick Start!

Follow this quick step-by-step for super-fast Python power :)

Download the latest version of
CircuitPython for this board via
CircuitPython.org

<https://adafru.it/HOC>

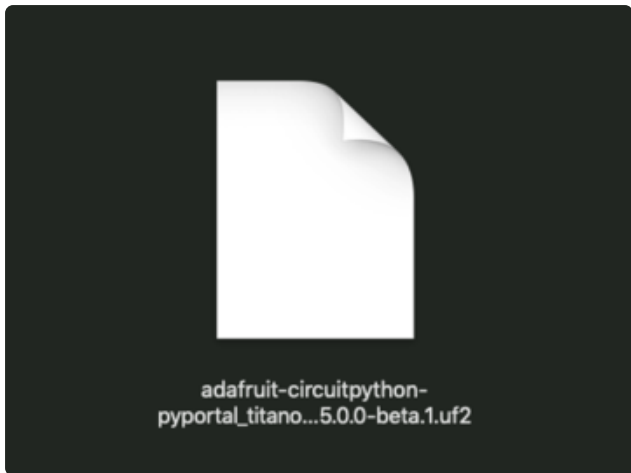

Click the link above to download the latest version of CircuitPython for the PyPortal Titano.

Download and save it to your desktop (or wherever is handy).

Plug your PyPortal into your computer using a known-good USB cable.

A lot of people end up using charge-only USB cables and it is very frustrating! So make sure you have a USB cable you know is good for data sync.

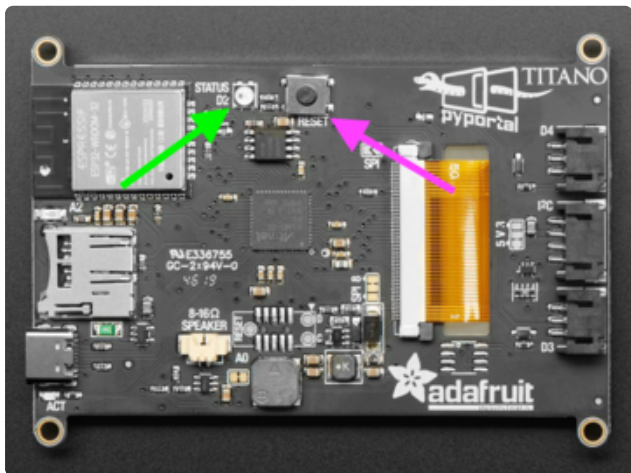

Double-click the Reset button on the top in the middle (magenta arrow) on your board, and you will see the NeoPixel RGB LED (green arrow) turn green. If it turns red, check the USB cable, try another USB port, etc. Note: The little red LED next to the USB connector will pulse red. That's ok!

If double-clicking doesn't work the first time, try again. Sometimes it can take a few tries to get the rhythm right!

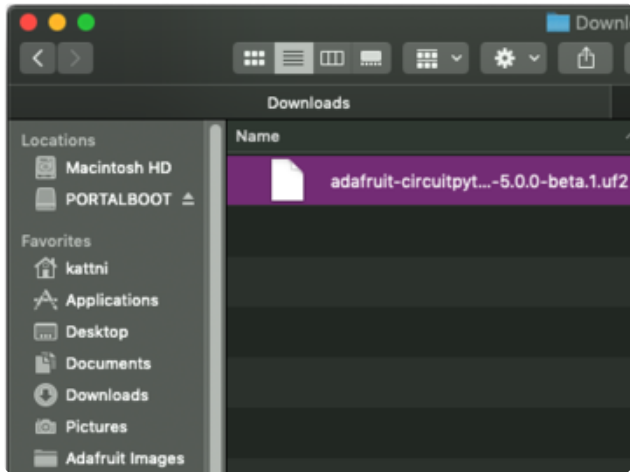

You will see a new disk drive appear called PORTALBOOT.

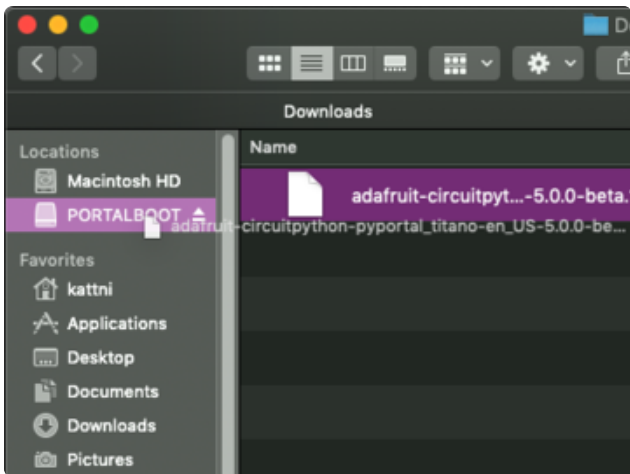

Drag the adafruit-circuitpython-pyportal-etc.uf2 file to PORTALBOOT.

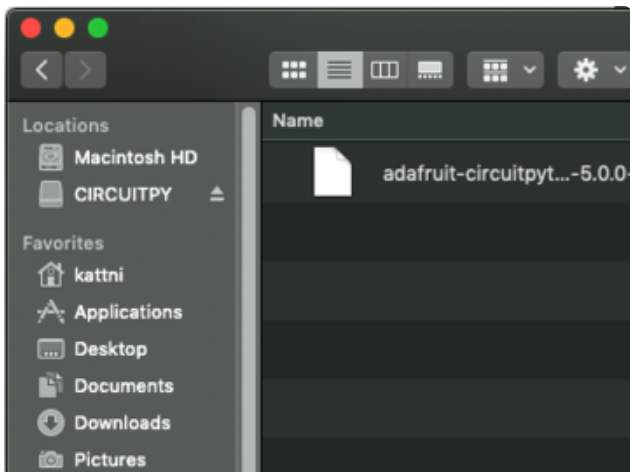

The LED will flash. Then, the PORTALBOOT drive will disappear and a new disk drive called CIRCUITPY will appear.

If you haven't added any code to your board, the only file that will be present is boot_out.txt. This is absolutely normal! It's time for you to add your code.py and get started!

That's it, you're done! :)

PyPortal Titano Default Files

Click below to download a zip of the files that shipped on the PyPortal Titano.

PyPortal Titano Default Files

<https://adafru.it/UGc>

Installing the Mu Editor

Mu is a simple code editor that works with the Adafruit CircuitPython boards. It's written in Python and works on Windows, MacOS, Linux and Raspberry Pi. The serial console is built right in so you get immediate feedback from your board's serial output!

Mu is our recommended editor - please use it (unless you are an experienced coder with a favorite editor already!).

Download and Install Mu



Download Mu from <https://codewith.mu> (<https://adafru.it/Be6>).

Click the Download link for downloads and installation instructions.

Click Start Here to find a wealth of other information, including extensive tutorials and how-to's.

Windows users: due to the nature of MSI installers, please remove old versions of Mu before installing the latest version.

Ubuntu users: Mu currently (checked May 4, 2022) does not install properly on Ubuntu 22.04. See <https://github.com/mu-editor/mu/issues> to track this issue. See <https://learn.adafruit.com/welcome-to-circuitpython/recommended-editors> and <https://learn.adafruit.com/welcome-to-circuitpython/pycharm-and-circuitpython> for other editors to use.

Starting Up Mu

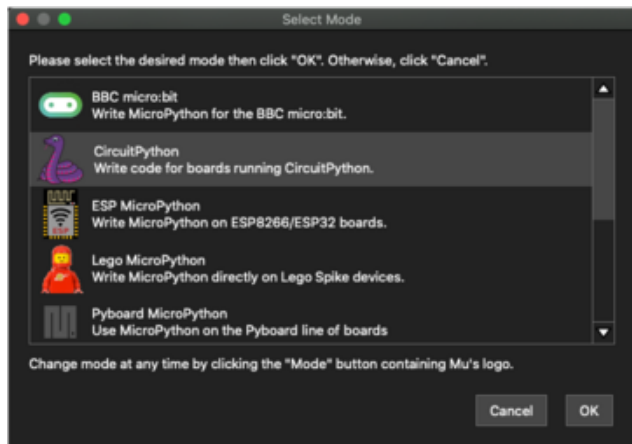

The first time you start Mu, you will be prompted to select your 'mode' - you can always change your mind later. For now please select CircuitPython!

The current mode is displayed in the lower right corner of the window, next to the "gear" icon. If the mode says "Microbit" or something else, click the Mode button in the upper left, and then choose "CircuitPython" in the dialog box that appears.

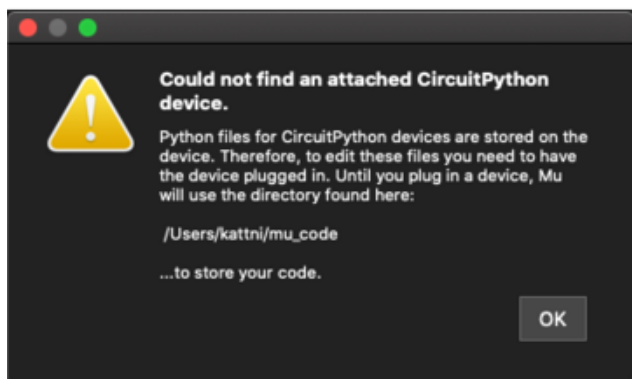

Mu attempts to auto-detect your board on startup, so if you do not have a CircuitPython board plugged in with a CIRCUITPY drive available, Mu will inform you where it will store any code you save until you plug in a board.

To avoid this warning, plug in a board and ensure that the CIRCUITPY drive is mounted before starting Mu.

Using Mu

You can now explore Mu! The three main sections of the window are labeled below; the button bar, the text editor, and the serial console / REPL.



Now you're ready to code! Let's keep going...

Creating and Editing Code

One of the best things about CircuitPython is how simple it is to get code up and running. This section covers how to create and edit your first CircuitPython program.

To create and edit code, all you'll need is an editor. There are many options. Adafruit strongly recommends using Mu! It's designed for CircuitPython, and it's really simple and easy to use, with a built in serial console!

If you don't or can't use Mu, there are a number of other editors that work quite well. The [Recommended Editors page \(https://adafru.it/Vue\)](https://adafru.it/Vue) has more details. Otherwise, make sure you do "Eject" or "Safe Remove" on Windows or "sync" on Linux after writing a file if you aren't using Mu. (This is not a problem on MacOS.)

Creating Code

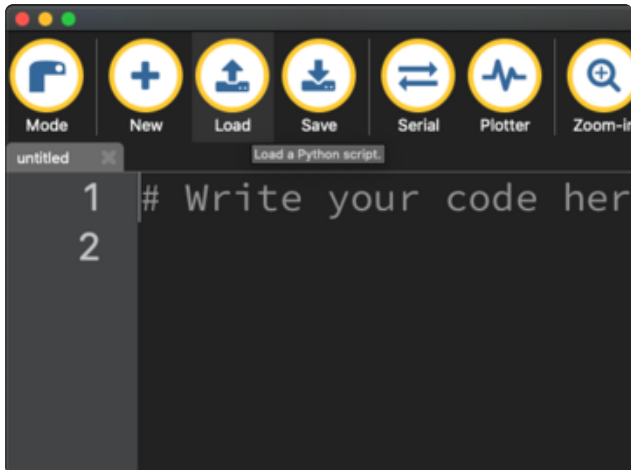

Installing CircuitPython generates a code.py file on your CIRCUITPY drive. To begin your own program, open your editor, and load the code.py file from the CIRCUITPY drive.

If you are using Mu, click the Load button in the button bar, navigate to the CIRCUITPY drive, and choose code.py.

Copy and paste the following code into your editor:

```
import board
import digitalio
import time

led = digitalio.DigitalInOut(board.LED)
led.direction = digitalio.Direction.OUTPUT

while True:
    led.value = True
    time.sleep(0.5)
    led.value = False
    time.sleep(0.5)
```

The KB2040, QT Py and the Trinkeys do not have a built-in little red LED! There is an addressable RGB NeoPixel LED. The above example will NOT work on the KB2040, QT Py or the Trinkeys!

If you're using a KB2040, QT Py or a Trinkey, please download the [NeoPixel blink example](https://adafru.it/UDU) (<https://adafru.it/UDU>).

The NeoPixel blink example uses the onboard NeoPixel, but the time code is the same. You can use the linked NeoPixel Blink example to follow along with this guide page.

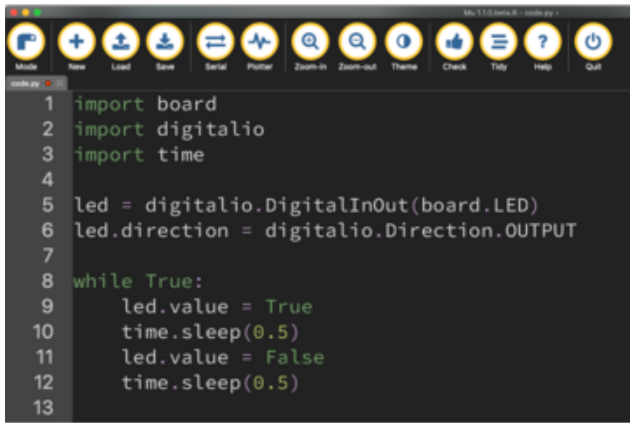

```
1 import board
2 import digitalio
3 import time
4
5 led = digitalio.DigitalInOut(board.LED)
6 led.direction = digitalio.Direction.OUTPUT
7
8 while True:
9     led.value = True
10    time.sleep(0.5)
11    led.value = False
12    time.sleep(0.5)
13
```

It will look like this. Note that under the `while True:` line, the next four lines begin with four spaces to indent them, and they're indented exactly the same amount. All the lines before that have no spaces before the text.

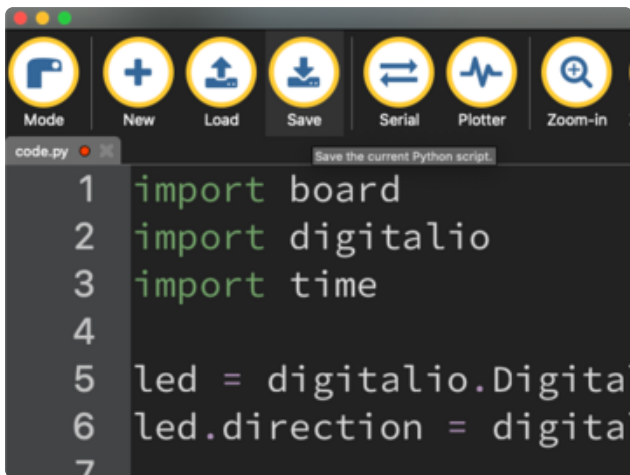

```
1 import board
2 import digitalio
3 import time
4
5 led = digitalio.Digital
6 led.direction = digita
7
```

Save the code.py file on your CIRCUITPY drive.

The little LED should now be blinking. Once per half-second.

Congratulations, you've just run your first CircuitPython program!

On most boards you'll find a tiny red LED.

On the ItsyBitsy nRF52840, you'll find a tiny blue LED.

On QT Py M0, QT Py RP2040, and the Trinkey series, you will find only an RGB NeoPixel LED.

Editing Code

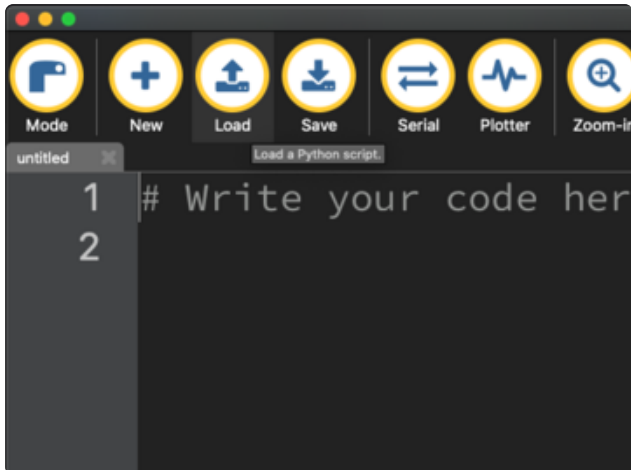

To edit code, open the code.py file on your CIRCUITPY drive into your editor.

Make the desired changes to your code. Save the file. That's it!

Your code changes are run as soon as the file is done saving.

There's one warning before you continue...

Don't click reset or unplug your board!

The CircuitPython code on your board detects when the files are changed or written and will automatically re-start your code. This makes coding very fast because you save, and it re-runs. If you unplug or reset the board before your computer finishes writing the file to your board, you can corrupt the drive. If this happens, you may lose the code you've written, so it's important to backup your code to your computer regularly.

There are a couple of ways to avoid filesystem corruption.

1. Use an editor that writes out the file completely when you save it.

Check out the [Recommended Editors page \(https://adafru.it/Vue\)](https://adafru.it/Vue) for details on different editing options.

If you are dragging a file from your host computer onto the CIRCUITPY drive, you still need to do step 2. Eject or Sync (below) to make sure the file is completely written.

2. Eject or Sync the Drive After Writing

If you are using one of our not-recommended-editors, not all is lost! You can still make it work.

On Windows, you can Eject or Safe Remove the CIRCUITPY drive. It won't actually eject, but it will force the operating system to save your file to disk. On Linux, use the sync command in a terminal to force the write to disk.

You also need to do this if you use Windows Explorer or a Linux graphical file manager to drag a file onto CIRCUITPY.

Oh No I Did Something Wrong and Now The CIRCUITPY Drive Doesn't Show Up!!!

Don't worry! Corrupting the drive isn't the end of the world (or your board!). If this happens, follow the steps found on the [Troubleshooting \(https://adafru.it/Den\)](https://adafru.it/Den) page of every board guide to get your board up and running again.

Back to Editing Code...

Now! Let's try editing the program you added to your board. Open your code.py file into your editor. You'll make a simple change. Change the first `0.5` to `0.1`. The code should look like this:

```
import board
import digitalio
import time

led = digitalio.DigitalInOut(board.LED)
led.direction = digitalio.Direction.OUTPUT

while True:
    led.value = True
    time.sleep(0.1)
    led.value = False
    time.sleep(0.5)
```

Leave the rest of the code as-is. Save your file. See what happens to the LED on your board? Something changed! Do you know why?

You don't have to stop there! Let's keep going. Change the second `0.5` to `0.1` so it looks like this:

```
while True:
    led.value = True
    time.sleep(0.1)
    led.value = False
    time.sleep(0.1)
```

Now it blinks really fast! You decreased the both time that the code leaves the LED on and off!

Now try increasing both of the `0.1` to `1`. Your LED will blink much more slowly because you've increased the amount of time that the LED is turned on and off.

Well done! You're doing great! You're ready to start into new examples and edit them to see what happens! These were simple changes, but major changes are done using the same process. Make your desired change, save it, and get the results. That's really all there is to it!

Naming Your Program File

CircuitPython looks for a code file on the board to run. There are four options: `code.txt`, `code.py`, `main.txt` and `main.py`. CircuitPython looks for those files, in that order, and then runs the first one it finds. While `code.py` is the recommended name for your code file, it is important to know that the other options exist. If your program doesn't seem to be updating as you work, make sure you haven't created another code file that's being read instead of the one you're working on.

Connecting to the Serial Console

One of the staples of CircuitPython (and programming in general!) is something called a "print statement". This is a line you include in your code that causes your code to output text. A print statement in CircuitPython (and Python) looks like this:

```
print("Hello, world!")
```

This line in your `code.py` would result in:

```
Hello, world!
```

However, these print statements need somewhere to display. That's where the serial console comes in!

The serial console receives output from your CircuitPython board sent over USB and displays it so you can see it. This is necessary when you've included a print statement in your code and you'd like to see what you printed. It is also helpful for troubleshooting errors, because your board will send errors and the serial console will display those too.

The serial console requires an editor that has a built in terminal, or a separate terminal program. A terminal is a program that gives you a text-based interface to perform various tasks.

Are you using Mu?

If so, good news! The serial console is built into Mu and will autodetect your board making using the serial console really really easy.

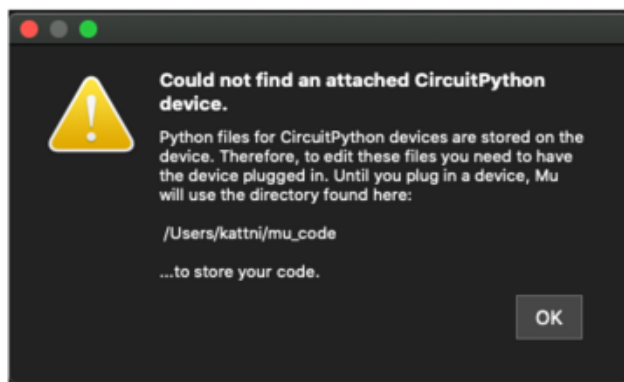

First, make sure your CircuitPython board is plugged in.

If you open Mu without a board plugged in, you may encounter the error seen here, letting you know no CircuitPython board was found and indicating where your code will be stored until you plug in a board.

If you are using Windows 7, make sure you installed the drivers (<https://adafru.it/VuB>).

Once you've opened Mu with your board plugged in, look for the Serial button in the button bar and click it.

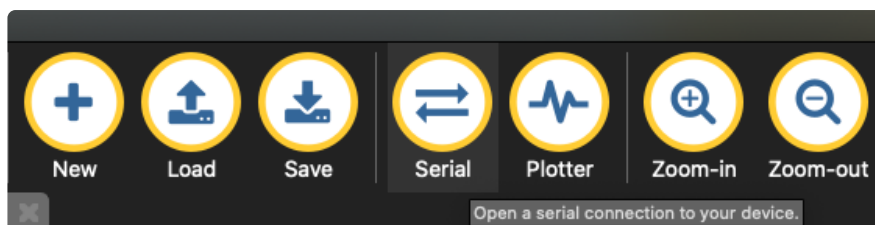

The Mu window will split in two, horizontally, and display the serial console at the bottom.

```
CircuitPython REPL
Auto-reload is on. Simply save files over USB to run them or enter REPL to disable.
code.py output:
Hello, world!

Code done running.

Press any key to enter the REPL. Use CTRL-D to reload.
```

If nothing appears in the serial console, it may mean your code is done running or has no print statements in it. Click into the serial console part of Mu, and press CTRL+D to reload.

Serial Console Issues or Delays on Linux

If you're on Linux, and are seeing multi-second delays connecting to the serial console, or are seeing "AT" and other gibberish when you connect, then the `modemmanager` service might be interfering. Just remove it; it doesn't have much use unless you're still using dial-up modems.

To remove `modemmanager`, type the following command at a shell:

```
sudo apt purge modemmanager
```

Setting Permissions on Linux

On Linux, if you see an error box something like the one below when you press the Serial button, you need to add yourself to a user group to have permission to connect to the serial console.



On Ubuntu and Debian, add yourself to the dialout group by doing:

```
sudo adduser $USER dialout
```

After running the command above, reboot your machine to gain access to the group. On other Linux distributions, the group you need may be different. See the [Advanced](#)

[Serial Console on Linux \(https://adafru.it/VAO\)](https://adafru.it/VAO) for details on how to add yourself to the right group.

Using Something Else?

If you're not using Mu to edit, are using or if for some reason you are not a fan of its built in serial console, you can run the serial console from a separate program.

Windows requires you to download a terminal program. [Check out the Advanced Serial Console on Windows page for more details. \(https://adafru.it/AAH\)](https://adafru.it/AAH)

MacOS has Terminal built in, though there are other options available for download. [Check the Advanced Serial Console on Mac page for more details. \(https://adafru.it/AAI\)](https://adafru.it/AAI)

Linux has a terminal program built in, though other options are available for download. [Check the Advanced Serial Console on Linux page for more details. \(https://adafru.it/VAO\)](https://adafru.it/VAO)

Once connected, you'll see something like the following.



```
Auto-reload is on. Simply save files over USB to run them or enter REPL to disable.
code.py output:
Hello, world!

Code done running.

Press any key to enter the REPL. Use CTRL-D to reload.
```

Interacting with the Serial Console

Once you've successfully connected to the serial console, it's time to start using it.

The code you wrote earlier has no output to the serial console. So, you're going to edit it to create some output.

Open your code.py file into your editor, and include a `print` statement. You can print anything you like! Just include your phrase between the quotation marks inside the parentheses. For example:

```
import board
import digitalio
import time
```



```
led = digitalio.DigitalInOut(board.LED)
led.direction = digitalio.Direction.OUTPUT

while True:
    print("Hello, CircuitPython!")
    led.value = True
    time.sleep(1)
    led.value = False
    time.sleep(1)
```

Save your file.

Now, let's go take a look at the window with our connection to the serial console.

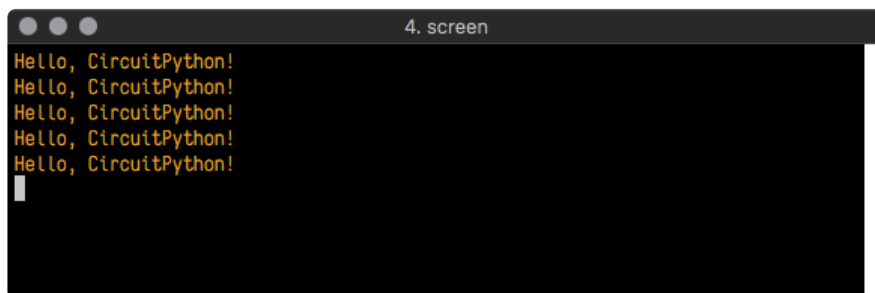

```
4. screen
Hello, CircuitPython!
Hello, CircuitPython!
Hello, CircuitPython!
Hello, CircuitPython!
Hello, CircuitPython!
```

Excellent! Our print statement is showing up in our console! Try changing the printed text to something else.

```
import board
import digitalio
import time

led = digitalio.DigitalInOut(board.LED)
led.direction = digitalio.Direction.OUTPUT

while True:
    print("Hello back to you!")
    led.value = True
    time.sleep(1)
    led.value = False
    time.sleep(1)
```

Keep your serial console window where you can see it. Save your file. You'll see what the serial console displays when the board reboots. Then you'll see your new change!

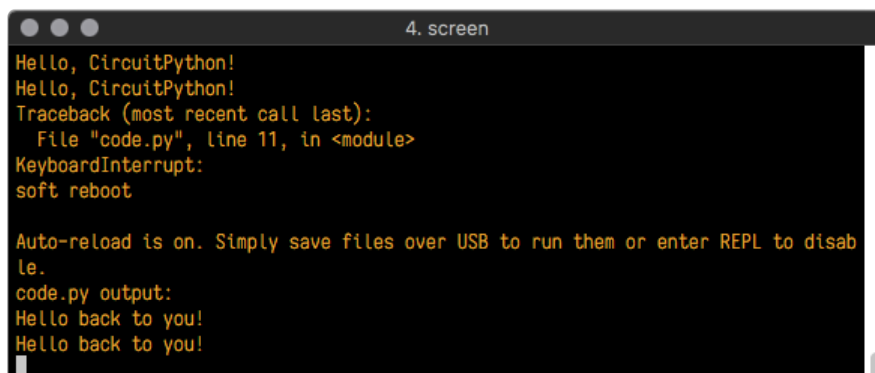

```
4. screen
Hello, CircuitPython!
Hello, CircuitPython!
Traceback (most recent call last):
  File "code.py", line 11, in <module>
KeyboardInterrupt:
soft reboot

Auto-reload is on. Simply save files over USB to run them or enter REPL to disable.
code.py output:
Hello back to you!
Hello back to you!
```

The **Traceback (most recent call last):** is telling you the last thing your board was doing before you saved your file. This is normal behavior and will happen every time the board resets. This is really handy for troubleshooting. Let's introduce an error so you can see how it is used.

Delete the **e** at the end of **True** from the line **led.value = True** so that it says **led.value = Tru**

```
import board
import digitalio
import time

led = digitalio.DigitalInOut(board.LED)
led.direction = digitalio.Direction.OUTPUT

while True:
    print("Hello back to you!")
    led.value = Tru
    time.sleep(1)
    led.value = False
    time.sleep(1)
```

Save your file. You will notice that your red LED will stop blinking, and you may have a colored status LED blinking at you. This is because the code is no longer correct and can no longer run properly. You need to fix it!

Usually when you run into errors, it's not because you introduced them on purpose. You may have 200 lines of code, and have no idea where your error could be hiding. This is where the serial console can help. Let's take a look!

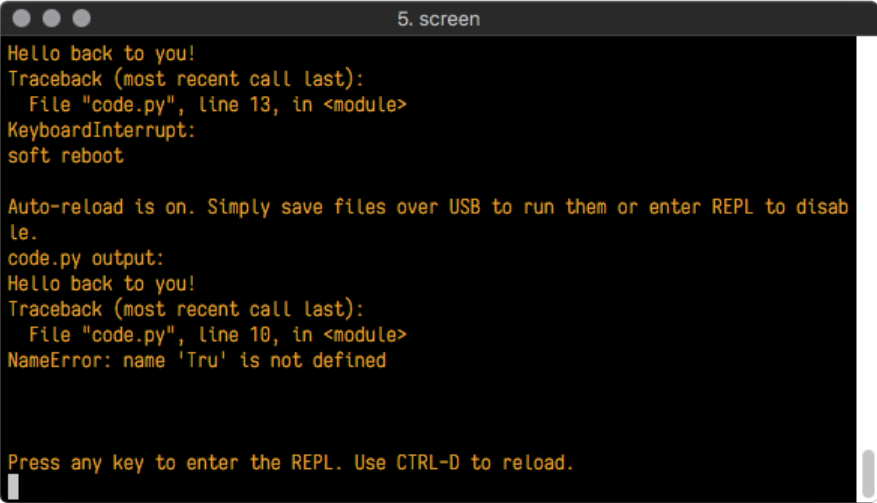
A screenshot of a serial console window titled "5. screen". The window shows the output of a Python program. It starts with "Hello back to you!". Then it shows a "Traceback (most recent call last):" error message. The error message indicates a "KeyboardInterrupt: soft reboot" and then shows the error details: "File 'code.py', line 13, in <module>". Below this, it says "Auto-reload is on. Simply save files over USB to run them or enter REPL to disable." and "code.py output: Hello back to you!". Then it shows another "Traceback (most recent call last):" error message: "File 'code.py', line 10, in <module> NameError: name 'Tru' is not defined". At the bottom, it says "Press any key to enter the REPL. Use CTRL-D to reload.".

```
5. screen
Hello back to you!
Traceback (most recent call last):
  File "code.py", line 13, in <module>
KeyboardInterrupt:
soft reboot

Auto-reload is on. Simply save files over USB to run them or enter REPL to disable.
code.py output:
Hello back to you!
Traceback (most recent call last):
  File "code.py", line 10, in <module>
NameError: name 'Tru' is not defined

Press any key to enter the REPL. Use CTRL-D to reload.
```

The **Traceback (most recent call last):** is telling you that the last thing it was able to run was **line 10** in your code. The next line is your error: **NameError: name 'Tru' is not defined**. This error might not mean a lot to you, but combined with knowing the issue is on line 10, it gives you a great place to start!

Go back to your code, and take a look at line 10. Obviously, you know what the problem is already. But if you didn't, you'd want to look at line 10 and see if you could figure it out. If you're still unsure, try googling the error to get some help. In this case, you know what to look for. You spelled True wrong. Fix the typo and save your file.

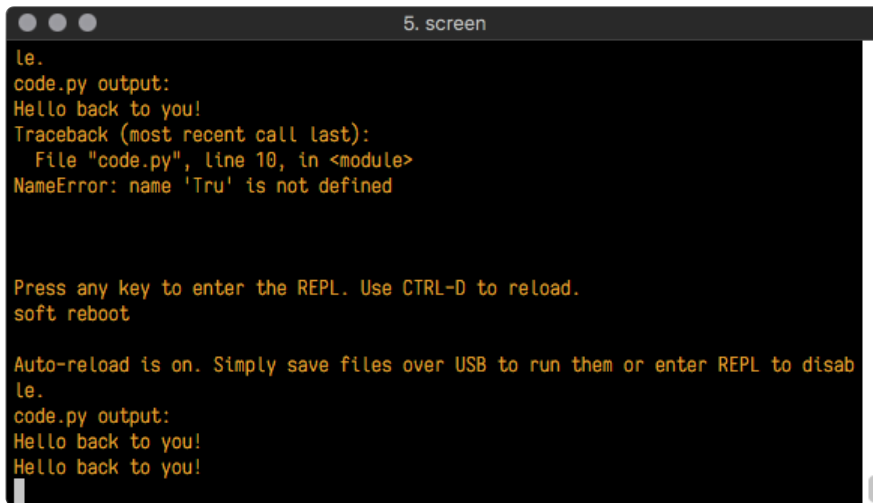

```
le.  
code.py output:  
Hello back to you!  
Traceback (most recent call last):  
  File "code.py", line 10, in <module>  
NameError: name 'Tru' is not defined  
  
Press any key to enter the REPL. Use CTRL-D to reload.  
soft reboot  
  
Auto-reload is on. Simply save files over USB to run them or enter REPL to disable.  
le.  
code.py output:  
Hello back to you!  
Hello back to you!
```

Nice job fixing the error! Your serial console is streaming and your red LED is blinking again.

The serial console will display any output generated by your code. Some sensors, such as a humidity sensor or a thermistor, receive data and you can use print statements to display that information. You can also use print statements for troubleshooting, which is called "print debugging". Essentially, if your code isn't working, and you want to know where it's failing, you can put print statements in various places to see where it stops printing.

The serial console has many uses, and is an amazing tool overall for learning and programming!

The REPL

The other feature of the serial connection is the Read-Evaluate-Print-Loop, or REPL. The REPL allows you to enter individual lines of code and have them run immediately. It's really handy if you're running into trouble with a particular program and can't figure out why. It's interactive so it's great for testing new ideas.

Entering the REPL

To use the REPL, you first need to be connected to the serial console. Once that connection has been established, you'll want to press CTRL+C.

If there is code running, in this case code measuring distance, it will stop and you'll see **Press any key to enter the REPL. Use CTRL-D to reload.** Follow those instructions, and press any key on your keyboard.

The **Traceback (most recent call last):** is telling you the last thing your board was doing before you pressed Ctrl + C and interrupted it. The **KeyboardInterrupt** is you pressing CTRL+C. This information can be handy when troubleshooting, but for now, don't worry about it. Just note that it is expected behavior.

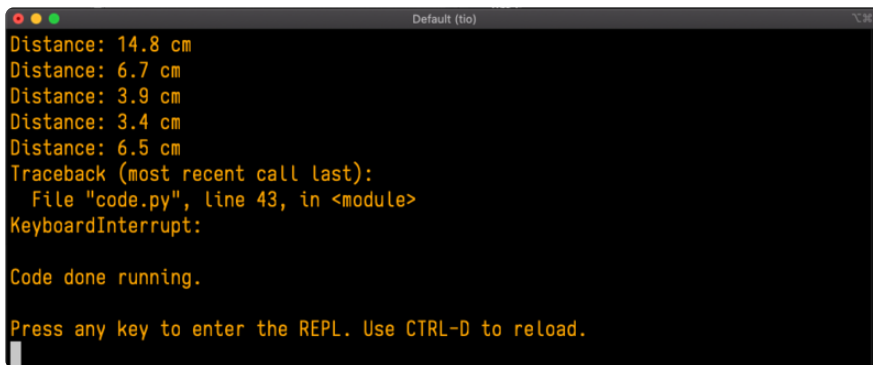

```
Distance: 14.8 cm
Distance: 6.7 cm
Distance: 3.9 cm
Distance: 3.4 cm
Distance: 6.5 cm
Traceback (most recent call last):
  File "code.py", line 43, in <module>
KeyboardInterrupt:

Code done running.

Press any key to enter the REPL. Use CTRL-D to reload.
```

If your code.py file is empty or does not contain a loop, it will show an empty output and **Code done running.** There is no information about what your board was doing before you interrupted it because there is no code running.

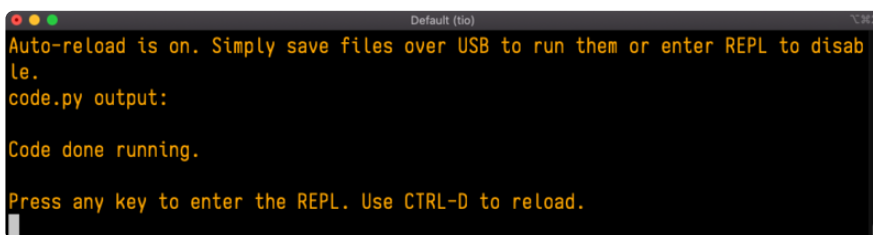

```
Auto-reload is on. Simply save files over USB to run them or enter REPL to disable.
code.py output:

Code done running.

Press any key to enter the REPL. Use CTRL-D to reload.
```

If you have no code.py on your CIRCUITPY drive, you will enter the REPL immediately after pressing CTRL+C. Again, there is no information about what your board was doing before you interrupted it because there is no code running.

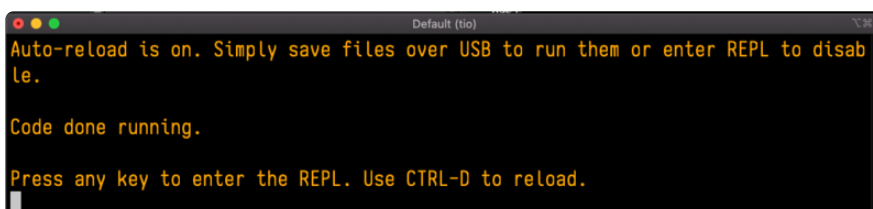

```
Auto-reload is on. Simply save files over USB to run them or enter REPL to disable.

Code done running.

Press any key to enter the REPL. Use CTRL-D to reload.
```

Regardless, once you press a key you'll see a `>>>` prompt welcoming you to the REPL!

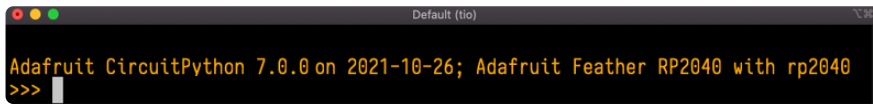

```
Default (tio)
Adafruit CircuitPython 7.0.0 on 2021-10-26; Adafruit Feather RP2040 with rp2040
>>> |
```

If you have trouble getting to the `>>>` prompt, try pressing `Ctrl + C` a few more times.

The first thing you get from the REPL is information about your board.



```
Adafruit CircuitPython 7.0.0 on 2021-10-26; Adafruit Feather RP2040 with rp2040
```

This line tells you the version of CircuitPython you're using and when it was released. Next, it gives you the type of board you're using and the type of microcontroller the board uses. Each part of this may be different for your board depending on the versions you're working with.

This is followed by the CircuitPython prompt.



```
>>>
```

Interacting with the REPL

From this prompt you can run all sorts of commands and code. The first thing you'll do is run `help()`. This will tell you where to start exploring the REPL. To run code in the REPL, type it in next to the REPL prompt.

Type `help()` next to the prompt in the REPL.

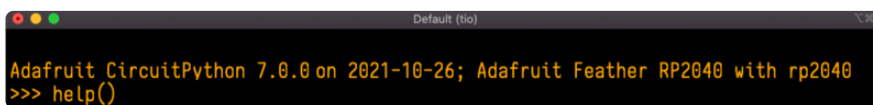

```
Default (tio)
Adafruit CircuitPython 7.0.0 on 2021-10-26; Adafruit Feather RP2040 with rp2040
>>> help()
```

Then press enter. You should then see a message.

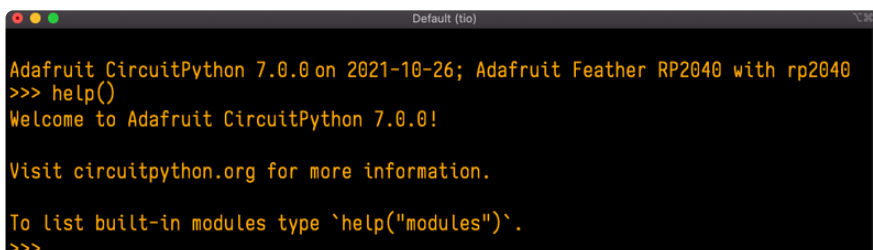

```
Default (tio)
Adafruit CircuitPython 7.0.0 on 2021-10-26; Adafruit Feather RP2040 with rp2040
>>> help()
Welcome to Adafruit CircuitPython 7.0.0!

Visit circuitpython.org for more information.

To list built-in modules type `help("modules")`.
>>>
```

First part of the message is another reference to the version of CircuitPython you're using. Second, a URL for the CircuitPython related project guides. Then... wait. What's this? `To list built-in modules type help("modules")`. Remember the modules you learned about while going through creating code? That's exactly what this is talking about! This is a perfect place to start. Let's take a look!

Type `help("modules")` into the REPL next to the prompt, and press enter.

```
>>> help("modules")
__main__      board                micropython         storage
_bleio        builtins             msgpack              struct
adafruit_bus_device busio                 neopixel_write     supervisor
adafruit_pixelbuf collections          onewireio           synthio
aesio         countio              os                   sys
alarm         digitalio            paralleldisplay     terminalio
analogio      displayio            pulseio             time
array         errno                pwmio               touchio
atexit        fontio               qrio                traceback
audiobusio   framebufferio       rainbowio           ulab
audiocore     gc                   random              usb_cdc
audiomixer   getpass             re                  usb_hid
audiomp3     imagecapture        rgbmatrix           usb_midi
audiopwmio   io                  rotaryio            vectorio
binascii     json                rp2pio              watchdog
bitbangio    keypad              rtc
bitmaptools  math                sdcardio
bitops       microcontroller    sharpdisplay
Plus any modules on the filesystem
>>>
```

This is a list of all the core modules built into CircuitPython, including `board`. Remember, `board` contains all of the pins on the board that you can use in your code. From the REPL, you are able to see that list!

Type `import board` into the REPL and press enter. It'll go to a new prompt. It might look like nothing happened, but that's not the case! If you recall, the `import` statement simply tells the code to expect to do something with that module. In this case, it's telling the REPL that you plan to do something with that module.

```
>>> import board
>>>
```

Next, type `dir(board)` into the REPL and press enter.

```
>>> dir(board)
['_class__', '_name__', 'A0', 'A1', 'A2', 'A3', 'D0', 'D1', 'D10', 'D11', 'D12', 'D13', 'D24', 'D25', 'D4', 'D5', 'D6', 'D9', 'I2C', 'LED', 'MISO', 'MOSI', 'NEOPIXEL', 'RX', 'SCK', 'SCL', 'SDA', 'SPI', 'TX', 'UART', 'board_id']
>>>
```

This is a list of all of the pins on your board that are available for you to use in your code. Each board's list will differ slightly depending on the number of pins available. Do you see `LED`? That's the pin you used to blink the red LED!

The REPL can also be used to run code. Be aware that any code you enter into the REPL isn't saved anywhere. If you're testing something new that you'd like to keep, make sure you have it saved somewhere on your computer as well!

Every programmer in every programming language starts with a piece of code that says, "Hello, World." You're going to say hello to something else. Type into the REPL:

```
print("Hello, CircuitPython!")
```

Then press enter.

```
>>> print("Hello, CircuitPython")
Hello, CircuitPython
>>> |
```

That's all there is to running code in the REPL! Nice job!

You can write single lines of code that run stand-alone. You can also write entire programs into the REPL to test them. Remember that nothing typed into the REPL is saved.

There's a lot the REPL can do for you. It's great for testing new ideas if you want to see if a few new lines of code will work. It's fantastic for troubleshooting code by entering it one line at a time and finding out where it fails. It lets you see what modules are available and explore those modules.

Try typing more into the REPL to see what happens!

Everything typed into the REPL is ephemeral. Once you reload the REPL or return to the serial console, nothing you typed will be retained in any memory space. So be sure to save any desired code you wrote somewhere else, or you'll lose it when you leave the current REPL instance!

Returning to the Serial Console

When you're ready to leave the REPL and return to the serial console, simply press CT RL+D. This will reload your board and reenter the serial console. You will restart the program you had running before entering the REPL. In the console window, you'll see any output from the program you had running. And if your program was affecting anything visual on the board, you'll see that start up again as well.

You can return to the REPL at any time!

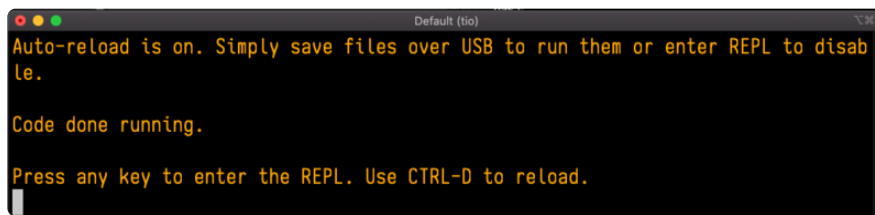

```
Default (tio)
Auto-reload is on. Simply save files over USB to run them or enter REPL to disable.
Code done running.
Press any key to enter the REPL. Use CTRL-D to reload.
```

CircuitPython Libraries

As CircuitPython development continues and there are new releases, Adafruit will stop supporting older releases. Visit <https://circuitpython.org/downloads> to download the latest version of CircuitPython for your board. You must download the CircuitPython Library Bundle that matches your version of CircuitPython. Please update CircuitPython and then visit <https://circuitpython.org/libraries> to download the latest Library Bundle.

Each CircuitPython program you run needs to have a lot of information to work. The reason CircuitPython is so simple to use is that most of that information is stored in other files and works in the background. These files are called libraries. Some of them are built into CircuitPython. Others are stored on your CIRCUITPY drive in a folder called lib. Part of what makes CircuitPython so great is its ability to store code separately from the firmware itself. Storing code separately from the firmware makes it easier to update both the code you write and the libraries you depend.

Your board may ship with a lib folder already, it's in the base directory of the drive. If not, simply create the folder yourself. When you first install CircuitPython, an empty lib directory will be created for you.

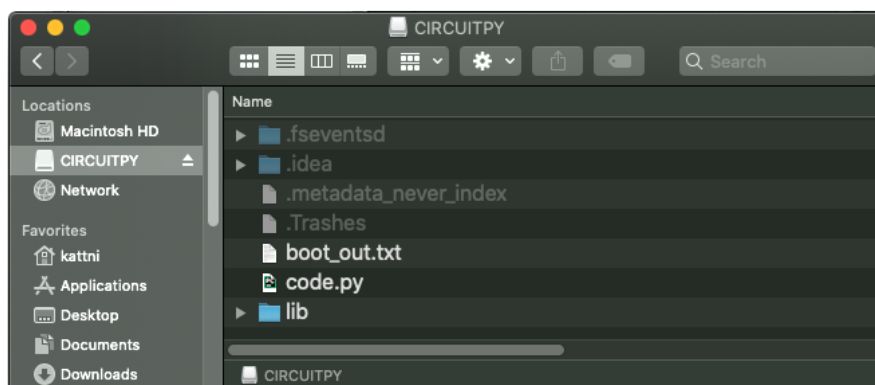

CircuitPython libraries work in the same way as regular Python modules so the [Python docs \(https://adafru.it/rar\)](https://adafru.it/rar) are an excellent reference for how it all should work. In

Python terms, you can place our library files in the lib directory because it's part of the Python path by default.

One downside of this approach of separate libraries is that they are not built in. To use them, one needs to copy them to the CIRCUITPY drive before they can be used. Fortunately, there is a library bundle.

The bundle and the library releases on GitHub also feature optimized versions of the libraries with the .mpy file extension. These files take less space on the drive and have a smaller memory footprint as they are loaded.

Due to the regular updates and space constraints, Adafruit does not ship boards with the entire bundle. Therefore, you will need to load the libraries you need when you begin working with your board. You can find example code in the guides for your board that depends on external libraries.

Either way, as you start to explore CircuitPython, you'll want to know how to get libraries on board.

The Adafruit Learn Guide Project Bundle

The quickest and easiest way to get going with a project from the Adafruit Learn System is by utilising the Project Bundle. Most guides now have a Download Project Bundle button available at the top of the full code example embed. This button downloads all the necessary files, including images, etc., to get the guide project up and running. Simply click, open the resulting zip, copy over the right files, and you're good to go!

The first step is to find the Download Project Bundle button in the guide you're working on.

The Download Project Bundle button is only available on full demo code embedded from GitHub in a Learn guide. Code snippets will NOT have the button available.

🏠 > Circuit Playground Express: Piano in the Key of Lime > Piano in the Key of Lime

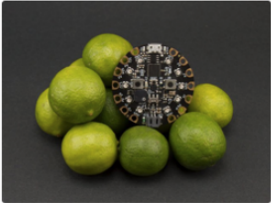

Piano in the Key of Lime

Now we'll take everything we learned and put it together!

Be sure to save your current code.py if you've changed anything you'd like to keep. Download the following file. Rename it to code.py and save it to your Circuit Playground Express.

Download Project Bundle Copy Code

```
# SPDX-FileCopyrightText: 2017 Kattni Rembor for Adafruit Industries
#
# SPDX-License-Identifier: MIT

from adafruit_circuitplayground import cp

while True:
    if cp.switch:
        print("Slide switch off!")
        cp.pixels.fill((0, 0, 0))
```

Circuit Playground Express: Piano in the Key of Lime
By [Kattni Rembor](#)
Create a full scale tone piano using CircuitPython, capacitive touch and some cute little fruits.

When you copy the contents of the Project Bundle to your CIRCUITPY drive, it will replace all the existing content! If you don't want to lose anything, ensure you copy your current code to your computer before you copy over the new Project Bundle content!

The Download Project Bundle button downloads a zip file. This zip contains a series of directories, nested within which is the code.py, any applicable assets like images or audio, and the lib/ folder containing all the necessary libraries. The following zip was downloaded from the [Piano in the Key of Lime guide \(https://adafru.it/-cW\)](https://adafru.it/-cW).

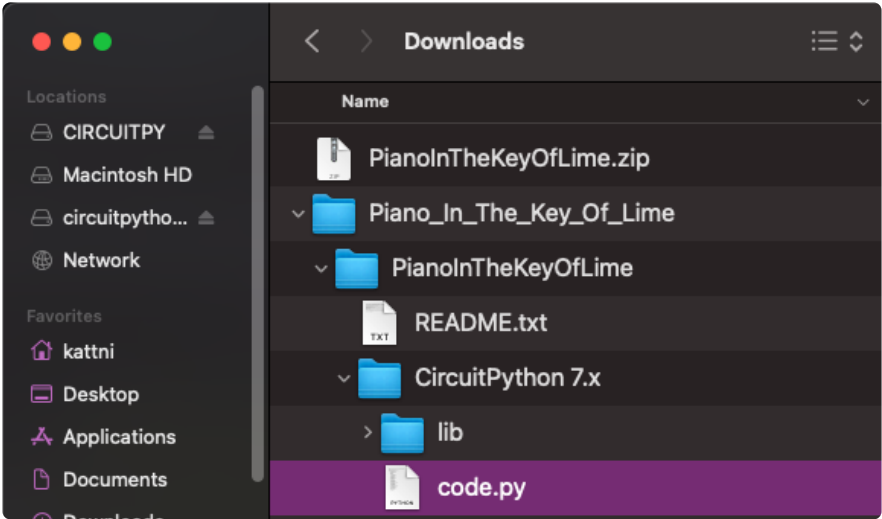

When you open the zip, you'll find some nested directories. Navigate through them until you find what you need. You'll eventually find a directory for your CircuitPython version (in this case, 7.x). In the version directory, you'll find the file and directory you need: code.py and lib/. Once you find the content you need, you can copy it all over to your CIRCUITPY drive, replacing any files already on the drive with the files from the freshly downloaded zip.

In some cases, there will be other files such as audio or images in the same directory as code.py and lib/. Make sure you include all the files when you copy things over!

Once you copy over all the relevant files, the project should begin running! If you find that the project is not running as expected, make sure you've copied ALL of the project files onto your microcontroller board.

That's all there is to using the Project Bundle!

The Adafruit CircuitPython Library Bundle

Adafruit provides CircuitPython libraries for much of the hardware they provide, including sensors, breakouts and more. To eliminate the need for searching for each library individually, the libraries are available together in the Adafruit CircuitPython Library Bundle. The bundle contains all the files needed to use each library.

Downloading the Adafruit CircuitPython Library Bundle

You can download the latest Adafruit CircuitPython Library Bundle release by clicking the button below. The libraries are being constantly updated and improved, so you'll always want to download the latest bundle.

Match up the bundle version with the version of CircuitPython you are running. For example, you would download the 6.x library bundle if you're running any version of CircuitPython 6, or the 7.x library bundle if you're running any version of CircuitPython 7, etc. If you mix libraries with major CircuitPython versions, you will get incompatible mpy errors due to changes in library interfaces possible during major version changes.

Click to visit circuitpython.org for the latest Adafruit CircuitPython Library Bundle

<https://adafru.it/ENC>

Download the bundle version that matches your CircuitPython firmware version. If you don't know the version, check the version info in boot_out.txt file on the CIRCUITPY drive, or the initial prompt in the CircuitPython REPL. For example, if you're running v7.0.0, download the 7.x library bundle.

There's also a py bundle which contains the uncompressed python files, you probably don't want that unless you are doing advanced work on libraries.

The CircuitPython Community Library Bundle

The CircuitPython Community Library Bundle is made up of libraries written and provided by members of the CircuitPython community. These libraries are often written when community members encountered hardware not supported in the Adafruit Bundle, or to support a personal project. The authors all chose to submit these libraries to the Community Bundle make them available to the community.

These libraries are maintained by their authors and are not supported by Adafruit. As you would with any library, if you run into problems, feel free to file an issue on the GitHub repo for the library. Bear in mind, though, that most of these libraries are supported by a single person and you should be patient about receiving a response. Remember, these folks are not paid by Adafruit, and are volunteering their personal time when possible to provide support.

Downloading the CircuitPython Community Library Bundle

You can download the latest CircuitPython Community Library Bundle release by clicking the button below. The libraries are being constantly updated and improved, so you'll always want to download the latest bundle.

Click for the latest CircuitPython
Community Library Bundle release

<https://adafru.it/VCn>

The link takes you to the latest release of the CircuitPython Community Library Bundle on GitHub. There are multiple versions of the bundle available. Download the bundle version that matches your CircuitPython firmware version. If you don't know the version, check the version info in `boot_out.txt` file on the CIRCUITPY drive, or the initial prompt in the CircuitPython REPL. For example, if you're running v7.0.0, download the 7.x library bundle.

Understanding the Bundle

After downloading the zip, extract its contents. This is usually done by double clicking on the zip. On Mac OSX, it places the file in the same directory as the zip.

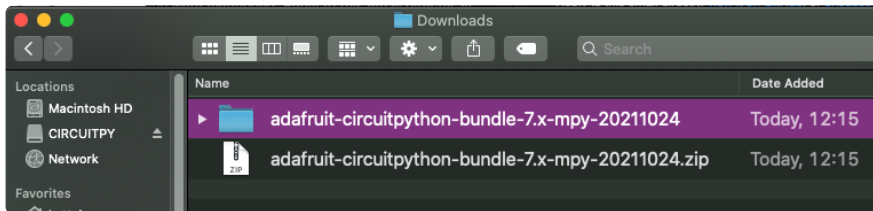

Open the bundle folder. Inside you'll find two information files, and two folders. One folder is the lib bundle, and the other folder is the examples bundle.

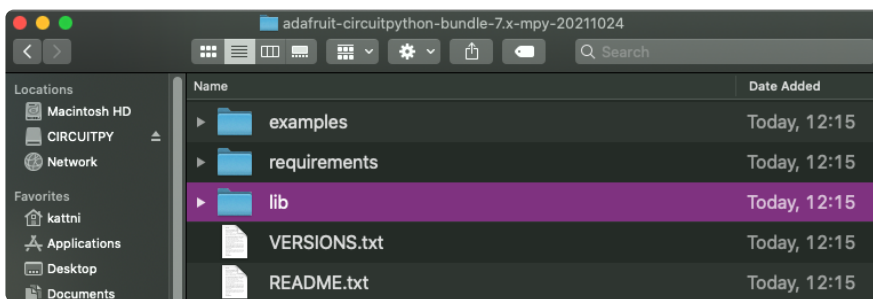

Now open the lib folder. When you open the folder, you'll see a large number of .mpy files, and folders.

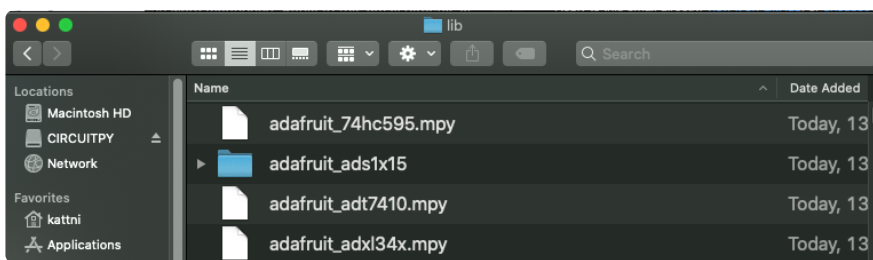

Example Files

All example files from each library are now included in the bundles in an examples directory (as seen above), as well as an examples-only bundle. These are included for two main reasons:

- Allow for quick testing of devices.
- Provide an example base of code, that is easily built upon for individualized purposes.

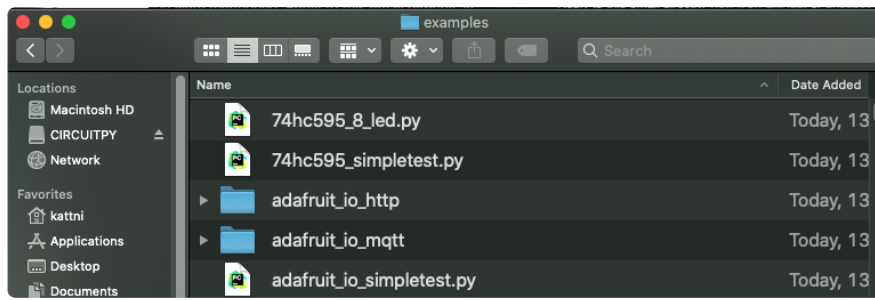

Copying Libraries to Your Board

First open the lib folder on your CIRCUITPY drive. Then, open the lib folder you extracted from the downloaded zip. Inside you'll find a number of folders and .mpy files. Find the library you'd like to use, and copy it to the lib folder on CIRCUITPY.

If the library is a directory with multiple .mpy files in it, be sure to copy the entire folder to CIRCUITPY/lib.

This also applies to example files. Open the examples folder you extracted from the downloaded zip, and copy the applicable file to your CIRCUITPY drive. Then, rename it to code.py to run it.

If a library has multiple .mpy files contained in a folder, be sure to copy the entire folder to CIRCUITPY/lib.

Understanding Which Libraries to Install

You now know how to load libraries on to your CircuitPython-compatible microcontroller board. You may now be wondering, how do you know which libraries you need to install? Unfortunately, it's not always straightforward. Fortunately, there is an obvious place to start, and a relatively simple way to figure out the rest. First up: the best place to start.

When you look at most CircuitPython examples, you'll see they begin with one or more `import` statements. These typically look like the following:

- `import library_or_module`

However, `import` statements can also sometimes look like the following:

- `from library_or_module import name`
- `from library_or_module.subpackage import name`
- `from library_or_module import name as local_name`

They can also have more complicated formats, such as including a `try` / `except` block, etc.

The important thing to know is that an `import` statement will always include the name of the module or library that you're importing.

Therefore, the best place to start is by reading through the `import` statements.

Here is an example import list for you to work with in this section. There is no setup or other code shown here, as the purpose of this section involves only the import list.

```
import time
import board
import neopixel
import adafruit_lis3dh
import usb_hid
from adafruit_hid.consumer_control import ConsumerControl
from adafruit_hid.consumer_control_code import ConsumerControlCode
```

Keep in mind, not all imported items are libraries. Some of them are almost always built-in CircuitPython modules. How do you know the difference? Time to visit the REPL.

In the [Interacting with the REPL section \(https://adafru.it/Awz\)](https://adafru.it/Awz) on [The REPL page \(https://adafru.it/Awz\)](https://adafru.it/Awz) in this guide, the `help("modules")` command is discussed. This command provides a list of all of the built-in modules available in CircuitPython for your board. So, if you connect to the serial console on your board, and enter the REPL, you can run `help("modules")` to see what modules are available for your board. Then, as you read through the `import` statements, you can, for the purposes of figuring out which libraries to load, ignore the statement that import modules.

The following is the list of modules built into CircuitPython for the Feather RP2040. Your list may look similar or be anything down to a significant subset of this list for smaller boards.

```
>>> help("modules")
__main__      board          micropython    storage
_bleio        builtins       msgpack         struct
adafruit_bus_device  collections    busio           neopixel_write  supervisor
adafruit_pixelbuf  countio        onewireio      synthio
aesio          digitalio      os              sys
alarm          displayio     paralleldisplay terminalio
analogio       errno         pwmio           touchio
array          fontio        qrio            traceback
audiobusio     framebufferio rainbowio        ulab
audiocore      gc            random          usb_cdc
audiomixer     getpass       re              usb_hid
audiomp3        imagecapture  rgbmatrix       usb_midi
audiopwmio     io            rotaryio        vectorio
binascii       json          rp2pio          watchdog
bitbangio      keypad        rtc
bitmaptools    math          sdcardio
bitops         microcontroller  sharpdisplay
```

Now that you know what you're looking for, it's time to read through the import statements. The first two, `time` and `board`, are on the modules list above, so they're built-in.

The next one, `neopixel`, is not on the module list. That means it's your first library! So, you would head over to the bundle zip you downloaded, and search for neopixel. There is a `neopixel.mpy` file in the bundle zip. Copy it over to the lib folder on your CIRCUITPY drive. The following one, `adafruit_lis3dh`, is also not on the module list. Follow the same process for `adafruit_lis3dh`, where you'll find `adafruit_lis3dh.mpy`, and copy that over.

The fifth one is `usb_hid`, and it is in the modules list, so it is built in. Often all of the built-in modules come first in the import list, but sometimes they don't! Don't assume that everything after the first library is also a library, and verify each import with the modules list to be sure. Otherwise, you'll search the bundle and come up empty!

The final two imports are not as clear. Remember, when `import` statements are formatted like this, the first thing after the `from` is the library name. In this case, the library name is `adafruit_hid`. A search of the bundle will find an `adafruit_hid` folder. When a library is a folder, you must copy the entire folder and its contents as it is in the bundle to the lib folder on your CIRCUITPY drive. In this case, you would copy the entire `adafruit_hid` folder to your CIRCUITPY/lib folder.

Notice that there are two imports that begin with `adafruit_hid`. Sometimes you will need to import more than one thing from the same library. Regardless of how many times you import the same library, you only need to load the library by copying over the `adafruit_hid` folder once.

That is how you can use your example code to figure out what libraries to load on your CircuitPython-compatible board!

There are cases, however, where libraries require other libraries internally. The internally required library is called a dependency. In the event of library dependencies, the easiest way to figure out what other libraries are required is to connect to the serial console and follow along with the `ImportError` printed there. The following is a very simple example of an `ImportError`, but the concept is the same for any missing library.

Example: `ImportError` Due to Missing Library

If you choose to load libraries as you need them, or you're starting fresh with an existing example, you may end up with code that tries to use a library you haven't yet loaded. This section will demonstrate what happens when you try to utilise a library that you don't have loaded on your board, and cover the steps required to resolve the issue.

This demonstration will only return an error if you do not have the required library loaded into the lib folder on your CIRCUITPY drive.

Let's use a modified version of the Blink example.

```
import board
import time
import simpleio

led = simpleio.DigitalOut(board.LED)

while True:
    led.value = True
    time.sleep(0.5)
    led.value = False
    time.sleep(0.5)
```

Save this file. Nothing happens to your board. Let's check the serial console to see what's going on.

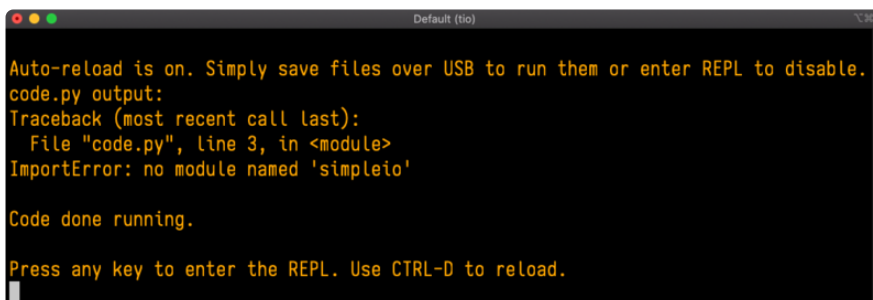

```
Default (tio)
Auto-reload is on. Simply save files over USB to run them or enter REPL to disable.
code.py output:
Traceback (most recent call last):
  File "code.py", line 3, in <module>
    ImportError: no module named 'simpleio'

Code done running.

Press any key to enter the REPL. Use CTRL-D to reload.
```

You have an `ImportError`. It says there is `no module named 'simpleio'`. That's the one you just included in your code!

Click the link above to download the correct bundle. Extract the lib folder from the downloaded bundle file. Scroll down to find `simpleio.mpy`. This is the library file you're looking for! Follow the steps above to load an individual library file.

The LED starts blinking again! Let's check the serial console.

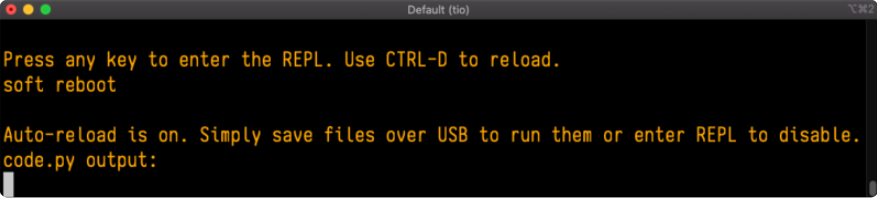

```
Default (tio)
Press any key to enter the REPL. Use CTRL-D to reload.
soft reboot

Auto-reload is on. Simply save files over USB to run them or enter REPL to disable.
code.py output:
```

No errors! Excellent. You've successfully resolved an `ImportError`!

If you run into this error in the future, follow along with the steps above and choose the library that matches the one you're missing.

Library Install on Non-Express Boards

If you have an M0 non-Express board such as Trinket M0, Gemma M0, QT Py M0, or one of the M0 Trinkeys, you'll want to follow the same steps in the example above to install libraries as you need them. Remember, you don't need to wait for an `ImportError` if you know what library you added to your code. Open the library bundle you downloaded, find the library you need, and drag it to the lib folder on your CIRCUITPY drive.

You can still end up running out of space on your M0 non-Express board even if you only load libraries as you need them. There are a number of steps you can use to try to resolve this issue. You'll find suggestions on the [Troubleshooting page \(https://adafruit.it/Den\)](https://adafruit.it/Den).

Updating CircuitPython Libraries and Examples

Libraries and examples are updated from time to time, and it's important to update the files you have on your CIRCUITPY drive.

To update a single library or example, follow the same steps above. When you drag the library file to your lib folder, it will ask if you want to replace it. Say yes. That's it!

A new library bundle is released every time there's an update to a library. Updates include things like bug fixes and new features. It's important to check in every so often to see if the libraries you're using have been updated.

CircUp CLI Tool

There is a command line interface (CLI) utility called [CircUp \(https://adafru.it/Tfi\)](https://adafru.it/Tfi) that can be used to easily install and update libraries on your device. Follow the directions on the [install page within the CircUp learn guide \(https://adafru.it/-Ad\)](https://adafru.it/-Ad). Once you've got it installed you run the command `circup update` in a terminal to interactively update all libraries on the connected CircuitPython device. See the [usage page in the CircUp guide \(https://adafru.it/-Ah\)](https://adafru.it/-Ah) for a full list of functionality

CircuitPython Pins and Modules

CircuitPython is designed to run on microcontrollers and allows you to interface with all kinds of sensors, inputs and other hardware peripherals. There are tons of guides showing how to wire up a circuit, and use CircuitPython to, for example, read data from a sensor, or detect a button press. Most CircuitPython code includes hardware setup which requires various modules, such as `board` or `digitalio`. You import these modules and then use them in your code. How does CircuitPython know to look for hardware in the specific place you connected it, and where do these modules come from?

This page explains both. You'll learn how CircuitPython finds the pins on your microcontroller board, including how to find the available pins for your board and what each pin is named. You'll also learn about the modules built into CircuitPython, including how to find all the modules available for your board.

CircuitPython Pins

When using hardware peripherals with a CircuitPython compatible microcontroller, you'll almost certainly be utilising pins. This section will cover how to access your board's pins using CircuitPython, how to discover what pins and board-specific objects are available in CircuitPython for your board, how to use the board-specific objects, and how to determine all available pin names for a given pin on your board.

import board

When you're using any kind of hardware peripherals wired up to your microcontroller board, the import list in your code will include `import board`. The `board` module is built into CircuitPython, and is used to provide access to a series of board-specific objects, including pins. Take a look at your microcontroller board. You'll notice that next to the pins are pin labels. You can always access a pin by its pin label. However, there are almost always multiple names for a given pin.

To see all the available board-specific objects and pins for your board, enter the REPL (`>>>`) and run the following commands:

```
import board
dir(board)
```

Here is the output for the QT Py. You may have a different board, and this list will vary, based on the board.

```
>>> import board
>>> dir(board)
['__class__', 'A0', 'A1', 'A10', 'A2', 'A3', 'A6', 'A7', 'A8', 'A9', 'D0', 'D1',
'D10', 'D2', 'D3', 'D4', 'D5', 'D6', 'D7', 'D8', 'D9', 'I2C', 'MISO', 'MOSI',
NEOPIXEL', 'NEOPIXEL_POWER', 'RX', 'SCK', 'SCL', 'SDA', 'SPI', 'TX', 'UART']
```

The following pins have labels on the physical QT Py board: A0, A1, A2, A3, SDA, SCL, TX, RX, SCK, MISO, and MOSI. You see that there are many more entries available in `board` than the labels on the QT Py.

You can use the pin names on the physical board, regardless of whether they seem to be specific to a certain protocol.

For example, you do not have to use the SDA pin for I2C - you can use it for a button or LED.

On the flip side, there may be multiple names for one pin. For example, on the QT Py, pin A0 is labeled on the physical board silkscreen, but it is available in CircuitPython as both `A0` and `D0`. For more information on finding all the names for a given pin, see the [What Are All the Available Pin Names? \(https://adafru.it/QkA\)](https://adafru.it/QkA) section below.

The results of `dir(board)` for CircuitPython compatible boards will look similar to the results for the QT Py in terms of the pin names, e.g. A0, D0, etc. However, some boards, for example, the Metro ESP32-S2, have different styled pin names. Here is the output for the Metro ESP32-S2.

```
>>> import board
>>> dir(board)
['__class__', 'A0', 'A1', 'A2', 'A3', 'A4', 'A5', 'DEBUG_RX', 'DEBUG_TX', 'I2C',
 'IO1', 'IO10', 'IO11', 'IO12', 'IO13', 'IO14', 'IO15', 'IO16', 'IO17', 'IO18',
 'IO2', 'IO21', 'IO3', 'IO33', 'IO34', 'IO35', 'IO36', 'IO37', 'IO4', 'IO42', 'IO
45', 'IO5', 'IO6', 'IO7', 'IO8', 'IO9', 'LED', 'MISO', 'MOSI', 'NEOPIXEL', 'RX',
 'SCK', 'SCL', 'SDA', 'SPI', 'TX', 'UART']
```

Note that most of the pins are named in an IO# style, such as IO1 and IO2. Those pins on the physical board are labeled only with a number, so an easy way to know how to access them in CircuitPython, is to run those commands in the REPL and find the pin naming scheme.

If your code is failing to run because it can't find a pin name you provided, verify that you have the proper pin name by running these commands in the REPL.

I2C, SPI, and UART

You'll also see there are often (but not always!) three special board-specific objects included: `I2C`, `SPI`, and `UART` - each one is for the default pin-set used for each of the three common protocol busses they are named for. These are called singletons.

What's a singleton? When you create an object in CircuitPython, you are instantiating ('creating') it. Instantiating an object means you are creating an instance of the object with the unique values that are provided, or "passed", to it.

For example, When you instantiate an I2C object using the `busio` module, it expects two pins: clock and data, typically SCL and SDA. It often looks like this:

```
i2c = busio.I2C(board.SCL, board.SDA)
```

Then, you pass the I2C object to a driver for the hardware you're using. For example, if you were using the TSL2591 light sensor and its CircuitPython library, the next line of code would be:

```
tsl2591 = adafruit_tsl2591.TSL2591(i2c)
```

However, CircuitPython makes this simpler by including the `I2C` singleton in the `board` module. Instead of the two lines of code above, you simply provide the singleton as the I2C object. So if you were using the TSL2591 and its CircuitPython library, the two above lines of code would be replaced with:

```
tsl2591 = adafruit_tsl2591.TSL2591(board.I2C())
```

The `board.I2C()`, `board.SPI()`, and `board.UART()` singletons do not exist on all boards. They exist if there are board markings for the default pins for those devices.

This eliminates the need for the `busio` module, and simplifies the code. Behind the scenes, the `board.I2C()` object is instantiated when you call it, but not before, and on subsequent calls, it returns the same object. Basically, it does not create an object until you need it, and provides the same object every time you need it. You can call `board.I2C()` as many times as you like, and it will always return the same object.

The UART/SPI/I2C singletons will use the 'default' bus pins for each board - often labeled as RX/TX (UART), MOSI/MISO/SCK (SPI), or SDA/SCL (I2C). Check your board documentation/pinout for the default busses.

What Are All the Available Names?

Many pins on CircuitPython compatible microcontroller boards have multiple names, however, typically, there's only one name labeled on the physical board. So how do you find out what the other available pin names are? Simple, with the following script! Each line printed out to the serial console contains the set of names for a particular pin.

On a microcontroller board running CircuitPython, connect to the serial console. Then, save the following as `code.py` on your CIRCUITPY drive.

```
# SPDX-FileCopyrightText: 2021 Kattni Rembor for Adafruit Industries
#
# SPDX-License-Identifier: MIT

"""CircuitPython Essentials Pin Map Script"""
import microcontroller
import board

board_pins = []
for pin in dir(microcontroller.pin):
    if isinstance(getattr(microcontroller.pin, pin), microcontroller.Pin):
        pins = []
        for alias in dir(board):
            if getattr(board, alias) is getattr(microcontroller.pin, pin):
                pins.append("board.{}".format(alias))
        if len(pins) > 0:
            board_pins.append(" ".join(pins))
for pins in sorted(board_pins):
    print(pins)
```

Here is the result when this script is run on QT Py:

```
board.A0 board.D0
board.A1 board.D1
board.A10 board.D10 board.MOSI
board.A2 board.D2
board.A3 board.D3
board.A6 board.D6 board.TX
board.A7 board.D7 board.RX
board.A8 board.D8 board.SCK
board.A9 board.D9 board.MISO
board.D4 board.SDA
board.D5 board.SCL
board.NEOPIXEL
board.NEOPIXEL_POWER
```

Each line represents a single pin. Find the line containing the pin name that's labeled on the physical board, and you'll find the other names available for that pin. For example, the first pin on the board is labeled A0. The first line in the output is `board.A0 board.D0`. This means that you can access pin A0 with both `board.A0` and `board.D0`.

You'll notice there are two "pins" that aren't labeled on the board but appear in the list: `board.NEOPIXEL` and `board.NEOPIXEL_POWER`. Many boards have several of these special pins that give you access to built-in board hardware, such as an LED or an on-board sensor. The Qt Py only has one on-board extra piece of hardware, a NeoPixel LED, so there's only the one available in the list. But you can also control whether or not power is applied to the NeoPixel, so there's a separate pin for that.

That's all there is to figuring out the available names for a pin on a compatible microcontroller board in CircuitPython!

Microcontroller Pin Names

The pin names available to you in the CircuitPython `board` module are not the same as the names of the pins on the microcontroller itself. The board pin names are aliases to the microcontroller pin names. If you look at the datasheet for your microcontroller, you'll likely find a pinout with a series of pin names, such as "PA18" or "GPIO5". If you want to get to the actual microcontroller pin name in CircuitPython, you'll need the `microcontroller.pin` module. As with `board`, you can run `dir(microcontroller.pin)` in the REPL to receive a list of the microcontroller pin names.

```
>>> import microcontroller
>>> dir(microcontroller.pin)
['_class_', 'PA02', 'PA03', 'PA04', 'PA05', 'PA06', 'PA07', 'PA08', 'PA09',
'PA10', 'PA11', 'PA15', 'PA16', 'PA17', 'PA18', 'PA19', 'PA22', 'PA23']
```

CircuitPython Built-In Modules

There is a set of modules used in most CircuitPython programs. One or more of these modules is always used in projects involving hardware. Often hardware requires installing a separate library from the Adafruit CircuitPython Bundle. But, if you try to find `board` or `digitalio` in the same bundle, you'll come up lacking. So, where do these modules come from? They're built into CircuitPython! You can find an comprehensive list of built-in CircuitPython modules and the technical details of their functionality from CircuitPython [here \(https://adafru.it/QkB\)](https://adafru.it/QkB) and the Python-like modules included [here \(https://adafru.it/QkC\)](https://adafru.it/QkC). However, not every module is available for every board due to size constraints or hardware limitations. How do you find out what modules are available for your board?

There are two options for this. You can check the [support matrix \(https://adafru.it/N2a\)](https://adafru.it/N2a), and search for your board by name. Or, you can use the REPL.

Plug in your board, connect to the serial console and enter the REPL. Type the following command.

```
help("modules")
```

```
>>> help("modules")
--main--      collections      neopixel_write  supervisor
_pixelbuf     digitalio        os               sys
adafruit_bus_device  displayio       pulseio         terminalio
analogio      errno            pwmio           time
array         fontio           random          touchio
audiocore     gamepad         re              usb_hid
audioio       gc               rotaryio        usb_midi
board         math             rtc              vectorio
builtins      microcontroller storage
busio        micropython     struct
Plus any modules on the filesystem
```

That's it! You now know two ways to find all of the modules built into CircuitPython for your compatible microcontroller board.

Frequently Asked Questions

These are some of the common questions regarding CircuitPython and CircuitPython microcontrollers.

As CircuitPython development continues and there are new releases, Adafruit will stop supporting older releases. Visit <https://circuitpython.org/downloads> to download the latest version of CircuitPython for your board. You must download

the CircuitPython Library Bundle that matches your version of CircuitPython. Please update CircuitPython and then visit <https://circuitpython.org/libraries> to download the latest Library Bundle.

I have to continue using CircuitPython 6.x or earlier. Where can I find compatible libraries?

We are no longer building or supporting the CircuitPython 6.x or earlier library bundles. We highly encourage you to [update CircuitPython to the latest version \(https://adafru.it/Em8\)](https://adafru.it/Em8) and use [the current version of the libraries \(https://adafru.it/ENC\)](https://adafru.it/ENC). However, if for some reason you cannot update, here are the last available library bundles for older versions:

- [2.x bundle \(https://adafru.it/FJA\)](https://adafru.it/FJA)
 - [3.x bundle \(https://adafru.it/FJB\)](https://adafru.it/FJB)
 - [4.x bundle \(https://adafru.it/QDL\)](https://adafru.it/QDL)
 - [5.x bundle \(https://adafru.it/QDJ\)](https://adafru.it/QDJ)
 - [6.x bundle \(https://adafru.it/Xmf\)](https://adafru.it/Xmf)
-

Is ESP8266 or ESP32 supported in CircuitPython? Why not?

We dropped ESP8266 support as of 4.x - For more information please read about it [here \(https://adafru.it/CiG\)](https://adafru.it/CiG)!

We do not support ESP32 because it does not have native USB.

We do support ESP32-S2, which has native USB.

How do I connect to the Internet with CircuitPython?

If you'd like to include WiFi in your project, check out [this guide \(https://adafru.it/F5X\)](https://adafru.it/F5X) on using AirLift with CircuitPython. For further project examples, and guides about using AirLift with specific hardware, check out [the Adafruit Learn System \(https://adafru.it/VBr\)](https://adafru.it/VBr).

Is there asyncio support in CircuitPython?

There is preliminary support for asyncio starting with CircuitPython 7.1.0. Read about using it in the [Cooperative Multitasking in CircuitPython \(https://adafru.it/XnA\)](https://adafru.it/XnA) Guide.

My RGB NeoPixel/DotStar LED is blinking funny colors - what does it mean?

The status LED can tell you what's going on with your CircuitPython board. [Read more here for what the colors mean! \(https://adafru.it/Den\)](https://adafru.it/Den)

What is a MemoryError?

Memory allocation errors happen when you're trying to store too much on the board. The CircuitPython microcontroller boards have a limited amount of memory available. You can have about 250 lines of code on the M0 Express boards. If you try to `import` too many libraries, a combination of large libraries, or run a program with too many lines of code, your code will fail to run and you will receive a `MemoryError` in the serial console.

What do I do when I encounter a MemoryError?

Try resetting your board. Each time you reset the board, it reallocates the memory. While this is unlikely to resolve your issue, it's a simple step and is worth trying.

Make sure you are using `.mpy` versions of libraries. All of the CircuitPython libraries are available in the bundle in a `.mpy` format which takes up less memory than `.py` format. Be sure that you're using [the latest library bundle \(https://adafru.it/uap\)](https://adafru.it/uap) for your version of CircuitPython.

If that does not resolve your issue, try shortening your code. Shorten comments, remove extraneous or unneeded code, or any other clean up you can do to shorten your code. If you're using a lot of functions, you could try moving those into a separate library, creating a `.mpy` of that library, and importing it into your code.

You can turn your entire file into a `.mpy` and `import` that into `code.py`. This means you will be unable to edit your code live on the board, but it can save you space.

Can the order of my `import` statements affect memory?

It can because the memory gets fragmented differently depending on allocation order and the size of objects. Loading `.mpy` files uses less memory so its recommended to do that for files you aren't editing.

How can I create my own .mpy files?

You can make your own .mpy versions of files with `mpy-cross`.

You can download `mpy-cross` for your operating system from [here \(https://adafru.it/QDK\)](https://adafru.it/QDK). Builds are available for Windows, macOS, x64 Linux, and Raspberry Pi Linux. Choose the latest `mpy-cross` whose version matches the version of CircuitPython you are using.

To make a .mpy file, run `./mpy-cross path/to/yourfile.py` to create a `yourfile.mpy` in the same directory as the original file.

How do I check how much memory I have free?

Run the following to see the number of bytes available for use:

```
import gc
gc.mem_free()
```

Does CircuitPython support interrupts?

No. CircuitPython does not currently support interrupts. We do not have an estimated time for when they will be included

Does Feather M0 support WINC1500?

No, WINC1500 will not fit into the M0 flash space.

Can AVR's such as ATmega328 or ATmega2560 run CircuitPython?

No.

Commonly Used Acronyms

CP or CPy = [CircuitPython \(https://adafru.it/KJD\)](https://adafru.it/KJD)

CPC = [Circuit Playground Classic \(https://adafru.it/ncE\)](https://adafru.it/ncE)

CPX = [Circuit Playground Express \(https://adafru.it/wpF\)](https://adafru.it/wpF)

CPB = [Circuit Playground Bluefruit \(https://adafru.it/Gpe\)](https://adafru.it/Gpe)

Troubleshooting

From time to time, you will run into issues when working with CircuitPython. Here are a few things you may encounter and how to resolve them.

As CircuitPython development continues and there are new releases, Adafruit will stop supporting older releases. Visit <https://circuitpython.org/downloads> to download the latest version of CircuitPython for your board. You must download the CircuitPython Library Bundle that matches your version of CircuitPython. Please update CircuitPython and then visit <https://circuitpython.org/libraries> to download the latest Library Bundle.

Always Run the Latest Version of CircuitPython and Libraries

As CircuitPython development continues and there are new releases, Adafruit will stop supporting older releases. You need to [update to the latest CircuitPython. \(https://adafru.it/Em8\)](https://adafru.it/Em8).

You need to download the CircuitPython Library Bundle that matches your version of CircuitPython. Please update CircuitPython and then [download the latest bundle \(https://adafru.it/ENC\)](https://adafru.it/ENC).

As new versions of CircuitPython are released, Adafruit will stop providing the previous bundles as automatically created downloads on the Adafruit CircuitPython Library Bundle repo. If you must continue to use an earlier version, you can still download the appropriate version of `mpy-cross` from the particular release of CircuitPython on the CircuitPython repo and create your own compatible .mpy library files. However, it is best to update to the latest for both CircuitPython and the library bundle.

I have to continue using CircuitPython 5.x or earlier. Where can I find compatible libraries?

Adafruit is no longer building or supporting the CircuitPython 5.x or earlier library bundles. You are highly encouraged to [update CircuitPython to the latest version \(https://adafru.it/Em8\)](https://adafru.it/Em8) and use [the current version of the libraries \(https://adafru.it/ENC\)](https://adafru.it/ENC).

However, if for some reason you cannot update, links to the previous bundles are available in the [FAQ \(https://adafru.it/FwY\)](https://adafru.it/FwY).

Bootloader (boardnameBOOT) Drive Not Present

You may have a different board.

Only Adafruit Express boards and the SAMD21 non-Express boards ship with the [UF2 bootloader \(https://adafru.it/zbX\)](https://adafru.it/zbX) installed. The Feather M0 Basic, Feather M0 Adalogger, and similar boards use a regular Arduino-compatible bootloader, which does not show a boardnameBOOT drive.

MakeCode

If you are running a [MakeCode \(https://adafru.it/zbY\)](https://adafru.it/zbY) program on Circuit Playground Express, press the reset button just once to get the CPLAYBOOT drive to show up. Pressing it twice will not work.

MacOS

DriveDx and its accompanying SAT SMART Driver can interfere with seeing the BOOT drive. [See this forum post \(https://adafru.it/sTc\)](https://adafru.it/sTc) for how to fix the problem.

Windows 10

Did you install the Adafruit Windows Drivers package by mistake, or did you upgrade to Windows 10 with the driver package installed? You don't need to install this package on Windows 10 for most Adafruit boards. The old version (v1.5) can interfere with recognizing your device. Go to Settings -> Apps and uninstall all the "Adafruit" driver programs.

Windows 7 or 8.1

To use a CircuitPython-compatible board with Windows 7 or 8.1, you must install a driver. Installation instructions are available [here \(https://adafru.it/VuB\)](https://adafru.it/VuB).

It is [recommended \(https://adafru.it/Amd\)](https://adafru.it/Amd) that you upgrade to Windows 10 if possible; an upgrade is probably still free for you. Check [here \(https://adafru.it/Amd\)](https://adafru.it/Amd).

The Windows Drivers installer was last updated in November 2020 (v2.5.0.0) . Windows 7 drivers for CircuitPython boards released since then, including RP2040 boards, are not yet available. The boards work fine on Windows 10. A new release of the drivers is in process.

You should now be done! Test by unplugging and replugging the board. You should see the CIRCUITPY drive, and when you double-click the reset button (single click on Circuit Playground Express running MakeCode), you should see the appropriate boardnameBOOT drive.

Let us know in the [Adafruit support forums \(https://adafru.it/jlf\)](https://adafru.it/jlf) or on the [Adafruit Discord \(\)](#) if this does not work for you!

Windows Explorer Locks Up When Accessing boardnameBOOT Drive

On Windows, several third-party programs that can cause issues. The symptom is that you try to access the boardnameBOOT drive, and Windows or Windows Explorer seems to lock up. These programs are known to cause trouble:

- AIDA64: to fix, stop the program. This problem has been reported to AIDA64. They acquired hardware to test, and released a beta version that fixes the problem. This may have been incorporated into the latest release. Please let us know in the forums if you test this.
- Hard Disk Sentinel
- Kaspersky anti-virus: To fix, you may need to disable Kaspersky completely. Disabling some aspects of Kaspersky does not always solve the problem. This problem has been reported to Kaspersky.
- ESET NOD32 anti-virus: There have been problems with at least version 9.0.386.0, solved by uninstallation.

Copying UF2 to boardnameBOOT Drive Hangs at 0% Copied

On Windows, a Western Digital (WD) utility that comes with their external USB drives can interfere with copying UF2 files to the boardnameBOOT drive. Uninstall that utility to fix the problem.

CIRCUITPY Drive Does Not Appear or Disappears Quickly

Kaspersky anti-virus can block the appearance of the CIRCUITPY drive. There has not yet been settings change discovered that prevents this. Complete uninstallation of Kaspersky fixes the problem.

Norton anti-virus can interfere with CIRCUITPY. A user has reported this problem on Windows 7. The user turned off both Smart Firewall and Auto Protect, and CIRCUITPY then appeared.

Sophos Endpoint security software [can cause CIRCUITPY to disappear \(https://adafru.it/ELr\)](https://adafru.it/ELr) and the BOOT drive to reappear. It is not clear what causes this behavior.

Device Errors or Problems on Windows

Windows can become confused about USB device installations. This is particularly true of Windows 7 and 8.1. It is [recommended \(https://adafru.it/Amd\)](https://adafru.it/Amd) that you upgrade to Windows 10 if possible; an upgrade is probably still free for you: see this [link \(https://adafru.it/V2a\)](https://adafru.it/V2a).

If not, try cleaning up your USB devices. Use [Uwe Sieber's Device Cleanup Tool \(https://adafru.it/RWd\)](https://adafru.it/RWd). Download and unzip the tool. Unplug all the boards and other USB devices you want to clean up. Run the tool as Administrator. You will see a listing like this, probably with many more devices. It is listing all the USB devices that are not currently attached.

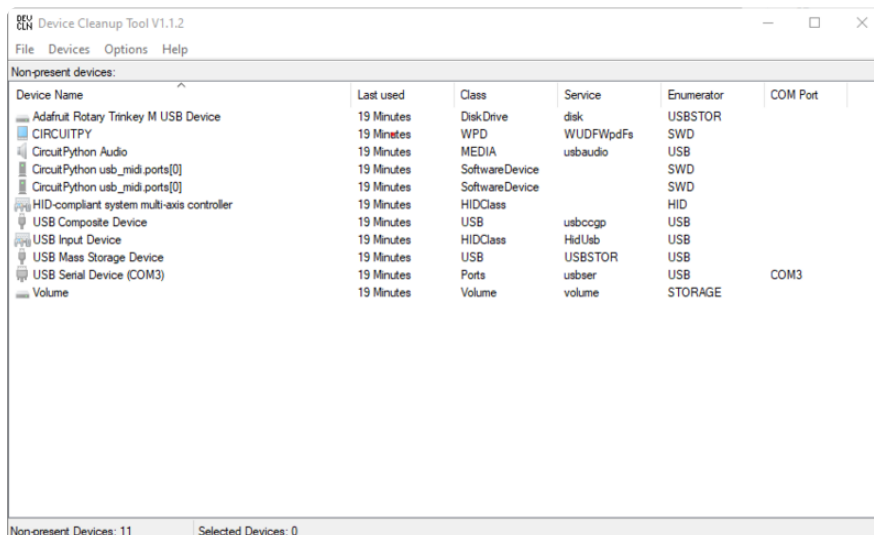

Select all the devices you want to remove, and then press Delete. It is usually safe just to select everything. Any device that is removed will get a fresh install when you plug it in. Using the Device Cleanup Tool also discards all the COM port assignments for the unplugged boards. If you have used many Arduino and CircuitPython boards, you have probably seen higher and higher COM port numbers used, seemingly without end. This will fix that problem.

Serial Console in Mu Not Displaying Anything

There are times when the serial console will accurately not display anything, such as, when no code is currently running, or when code with no serial output is already running before you open the console. However, if you find yourself in a situation where you feel it should be displaying something like an error, consider the following.

Depending on the size of your screen or Mu window, when you open the serial console, the serial console panel may be very small. This can be a problem. A basic CircuitPython error takes 10 lines to display!

```
Auto-reload is on. Simply save files over USB to run them or enter REPL to disable.
code.py output:
Traceback (most recent call last):
  File "code.py", line 7
SyntaxError: invalid syntax
```

Press any key to enter the REPL. Use CTRL-D to reload.

More complex errors take even more lines!

Therefore, if your serial console panel is five lines tall or less, you may only see blank lines or blank lines followed by **Press any key to enter the REPL. Use CTRL-D to reload.** . If this is the case, you need to either mouse over the top of the panel to utilise the option to resize the serial panel, or use the scrollbar on the right side to scroll up and find your message.

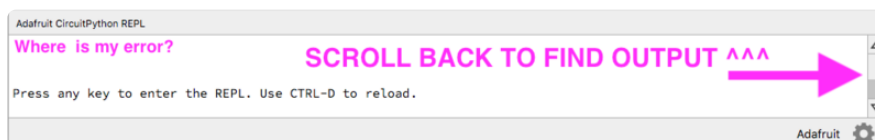

This applies to any kind of serial output whether it be error messages or print statements. So before you start trying to debug your problem on the hardware side,

be sure to check that you haven't simply missed the serial messages due to serial output panel height.

code.py Restarts Constantly

CircuitPython will restart code.py if you or your computer writes to something on the CIRCUITPY drive. This feature is called auto-reload, and lets you test a change to your program immediately.

Some utility programs, such as backup, anti-virus, or disk-checking apps, will write to the CIRCUITPY as part of their operation. Sometimes they do this very frequently, causing constant restarts.

Acronis True Image and related Acronis programs on Windows are known to cause this problem. It is possible to prevent this by [disabling the " \(https://adafru.it/XDZ\)Acronis Managed Machine Service Mini" \(https://adafru.it/XDZ\)](https://adafru.it/XDZ).

If you cannot stop whatever is causing the writes, you can disable auto-reload by putting this code in boot.py or code.py:

```
import supervisor
supervisor.disable_autoreload()
```

CircuitPython RGB Status Light

Nearly all CircuitPython-capable boards have a single NeoPixel or DotStar RGB LED on the board that indicates the status of CircuitPython. A few boards designed before CircuitPython existed, such as the Feather M0 Basic, do not.

Circuit Playground Express and Circuit Playground Bluefruit have multiple RGB LEDs, but do NOT have a status LED. The LEDs are all green when in the bootloader. In versions before 7.0.0, they do NOT indicate any status while running CircuitPython.

CircuitPython 7.0.0 and Later

The status LED blinks were changed in CircuitPython 7.0.0 in order to save battery power and simplify the blinks. These blink patterns will occur on single color LEDs when the board does not have any RGB LEDs. Speed and blink count also vary for this reason.

On start up, the LED will blink YELLOW multiple times for 1 second. Pressing reset during this time will restart the board and then enter safe mode. On Bluetooth capable boards, after the yellow blinks, there will be a set of faster blue blinks. Pressing reset during the BLUE blinks will clear Bluetooth information and start the device in discoverable mode, so it can be used with a BLE code editor.

Once started, CircuitPython will blink a pattern every 5 seconds when no user code is running to indicate why the code stopped:

- 1 GREEN blink: Code finished without error.
- 2 RED blinks: Code ended due to an exception. Check the serial console for details.
- 3 YELLOW blinks: CircuitPython is in safe mode. No user code was run. Check the serial console for safe mode reason.

When in the REPL, CircuitPython will set the status LED to WHITE. You can change the LED color from the REPL. The status indicator will not persist on non-NeoPixel or DotStar LEDs.

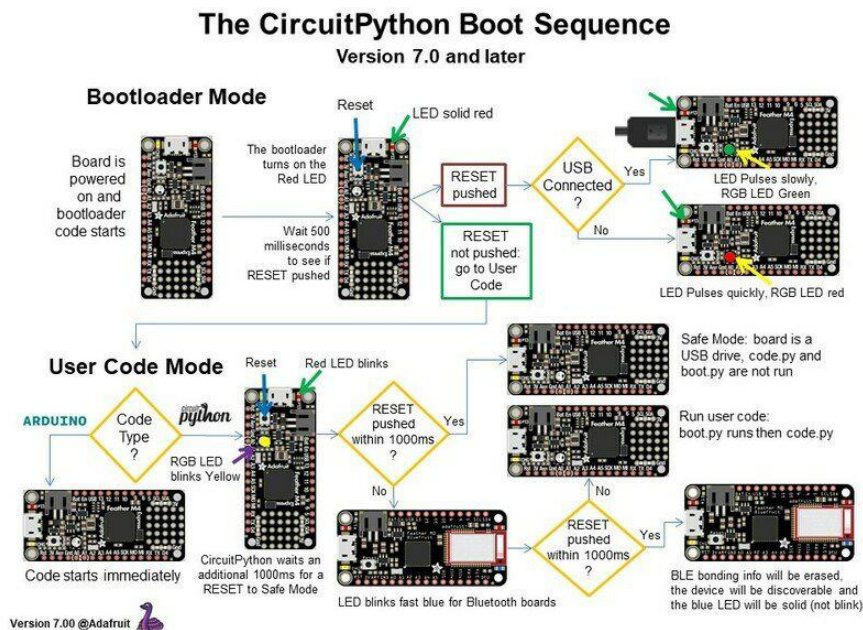

CircuitPython 6.3.0 and earlier

Here's what the colors and blinking mean:

- steady GREEN: code.py (or code.txt, main.py, or main.txt) is running
- pulsing GREEN: code.py (etc.) has finished or does not exist

- steady YELLOW at start up: (4.0.0-alpha.5 and newer) CircuitPython is waiting for a reset to indicate that it should start in safe mode
- pulsing YELLOW: Circuit Python is in safe mode: it crashed and restarted
- steady WHITE: REPL is running
- steady BLUE: boot.py is running

Colors with multiple flashes following indicate a Python exception and then indicate the line number of the error. The color of the first flash indicates the type of error:

- GREEN: IndentationError
- CYAN: SyntaxError
- WHITE: NameError
- ORANGE: OSError
- PURPLE: ValueError
- YELLOW: other error

These are followed by flashes indicating the line number, including place value. WHITE flashes are thousands' place, BLUE are hundreds' place, YELLOW are tens' place, and CYAN are one's place. So for example, an error on line 32 would flash YELLOW three times and then CYAN two times. Zeroes are indicated by an extra-long dark gap.

The CircuitPython Boot Sequence

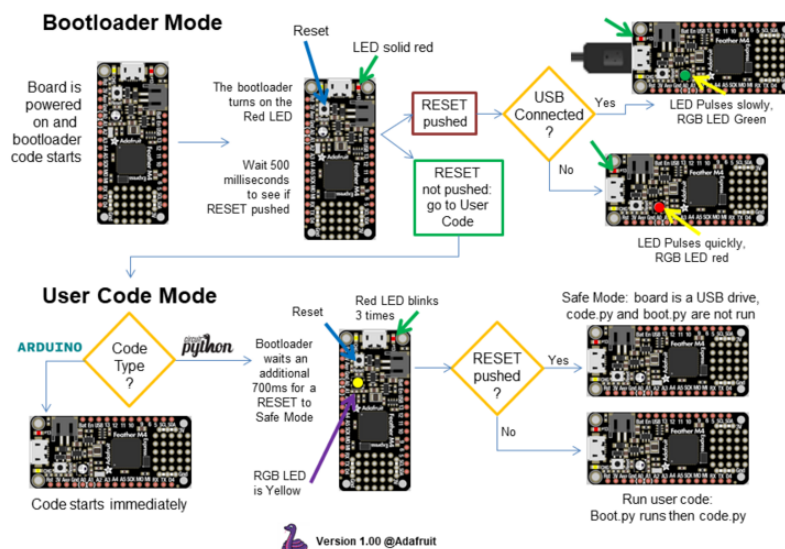

Serial console showing `ValueError: Incompatible .mpy file`

This error occurs when importing a module that is stored as a .mpy binary file that was generated by a different version of CircuitPython than the one its being loaded into. In particular, the mpy binary format changed between CircuitPython versions 6.x and 7.x, 2.x and 3.x, and 1.x and 2.x.

So, for instance, if you upgraded to CircuitPython 7.x from 6.x you'll need to download a newer version of the library that triggered the error on `import`. All libraries are available in the [Adafruit bundle \(https://adafru.it/y8E\)](https://adafru.it/y8E).

CIRCUITPY Drive Issues

You may find that you can no longer save files to your CIRCUITPY drive. You may find that your CIRCUITPY stops showing up in your file explorer, or shows up as NO_NAME. These are indicators that your filesystem has issues. When the CIRCUITPY disk is not safely ejected before being reset by the button or being disconnected from USB, it may corrupt the flash drive. It can happen on Windows, Mac or Linux, though it is more common on Windows.

Be aware, if you have used Arduino to program your board, CircuitPython is no longer able to provide the USB services. You will need to reload CircuitPython to resolve this situation.

The easiest first step is to reload CircuitPython. Double-tap reset on the board so you get a boardnameBOOT drive rather than a CIRCUITPY drive, and copy the latest version of CircuitPython (.uf2) back to the board. This may restore CIRCUITPY functionality.

If reloading CircuitPython does not resolve your issue, the next step is to try putting the board into safe mode.

Safe Mode

Whether you've run into a situation where you can no longer edit your code.py on your CIRCUITPY drive, your board has gotten into a state where CIRCUITPY is read-only, or you have turned off the CIRCUITPY drive altogether, safe mode can help.

Safe mode in CircuitPython does not run any user code on startup, and disables auto-reload. This means a few things. First, safe mode bypasses any code in `boot.py` (where you can set `CIRCUITPY` read-only or turn it off completely). Second, it does not run the code in `code.py`. And finally, it does not automatically soft-reload when data is written to the `CIRCUITPY` drive.

Therefore, whatever you may have done to put your board in a non-interactive state, safe mode gives you the opportunity to correct it without losing all of the data on the `CIRCUITPY` drive.

Entering Safe Mode in CircuitPython 7.x

To enter safe mode when using CircuitPython 7.x, plug in your board or hit reset (highlighted in red above). Immediately after the board starts up or resets, it waits 1000ms. On some boards, the onboard status LED will blink yellow during that time. If you press reset during that 1000ms, the board will start up in safe mode. It can be difficult to react to the yellow LED, so you may want to think of it simply as a "slow" double click of the reset button. (Remember, a fast double click of reset enters the bootloader.)

Entering Safe Mode in CircuitPython 6.x

To enter safe mode when using CircuitPython 6.x, plug in your board or hit reset (highlighted in red above). Immediately after the board starts up or resets, it waits 700ms. On some boards, the onboard status LED (highlighted in green above) will turn solid yellow during this time. If you press reset during that 700ms, the board will start up in safe mode. It can be difficult to react to the yellow LED, so you may want to think of it simply as a slow double click of the reset button. (Remember, a fast double click of reset enters the bootloader.)

In Safe Mode

Once you've entered safe mode successfully in CircuitPython 6.x, the LED will pulse yellow.

If you successfully enter safe mode on CircuitPython 7.x, the LED will intermittently blink yellow three times.

If you connect to the serial console, you'll find the following message.

```
Auto-reload is off.  
Running in safe mode! Not running saved code.  
  
CircuitPython is in safe mode because you pressed the reset button during boot.  
Press again to exit safe mode.  
  
Press any key to enter the REPL. Use CTRL-D to reload.
```

You can now edit the contents of the CIRCUITPY drive. Remember, your code will not run until you press the reset button, or unplug and plug in your board, to get out of safe mode.

At this point, you'll want to remove any user code in code.py and, if present, the boot.py file from CIRCUITPY. Once removed, tap the reset button, or unplug and plug in your board, to restart CircuitPython. This will restart the board and may resolve your drive issues. If resolved, you can begin coding again as usual.

If safe mode does not resolve your issue, the board must be completely erased and CircuitPython must be reloaded onto the board.

You WILL lose everything on the board when you complete the following steps. If possible, make a copy of your code before continuing.

To erase CIRCUITPY: `storage.erase_filesystem()`

CircuitPython includes a built-in function to erase and reformat the filesystem. If you have a version of CircuitPython older than 2.3.0 on your board, you can [update to the newest version](https://adafru.it/Amd) (<https://adafru.it/Amd>) to do this.

1. [Connect to the CircuitPython REPL](https://adafru.it/Bec) (<https://adafru.it/Bec>) using Mu or a terminal program.
2. Type the following into the REPL:

```
>>> import storage  
>>> storage.erase_filesystem()
```

CIRCUITPY will be erased and reformatted, and your board will restart. That's it!

Erase CIRCUITPY Without Access to the REPL

If you can't access the REPL, or you're running a version of CircuitPython previous to 2.3.0 and you don't want to upgrade, there are options available for some specific boards.

The options listed below are considered to be the "old way" of erasing your board. The method shown above using the REPL is highly recommended as the best method for erasing your board.

If at all possible, it is recommended to use the REPL to erase your CIRCUITPY drive. The REPL method is explained above.

For the specific boards listed below:

If the board you are trying to erase is listed below, follow the steps to use the file to erase your board.

1. Download the correct erase file:

Circuit Playground Express

<https://adafru.it/AdI>

Feather M0 Express

<https://adafru.it/AdJ>

Feather M4 Express

<https://adafru.it/EVK>

Metro M0 Express

<https://adafru.it/AdK>

Metro M4 Express QSPI Eraser

<https://adafru.it/EoM>

Trellis M4 Express (QSPI)

<https://adafru.it/DjD>

Grand Central M4 Express (QSPI)

<https://adafru.it/DBA>

PyPortal M4 Express (QSPI)

<https://adafru.it/Eca>

Circuit Playground Bluefruit (QSPI)

<https://adafru.it/Gnc>

Monster M4SK (QSPI)

<https://adafru.it/GAN>

PyBadge/PyGamer QSPI Eraser.UF2

<https://adafru.it/GAO>

CLUE_Flash_Erase.UF2

<https://adafru.it/Jat>

Matrix_Portal_M4_(QSPI).UF2

<https://adafru.it/Q5B>

2. Double-click the reset button on the board to bring up the boardnameBOOT drive.
3. Drag the erase .uf2 file to the boardnameBOOT drive.
4. The status LED will turn yellow or blue, indicating the erase has started.
5. After approximately 15 seconds, the status LED will light up green. On the NeoTrellis M4 this is the first NeoPixel on the grid
6. Double-click the reset button on the board to bring up the boardnameBOOT drive.
7. [Drag the appropriate latest release of CircuitPython \(https://adafru.it/Em8\)](https://adafru.it/Em8) .uf2 file to the boardnameBOOT drive.

It should reboot automatically and you should see CIRCUITPY in your file explorer again.

If the LED flashes red during step 5, it means the erase has failed. Repeat the steps starting with 2.

[If you haven't already downloaded the latest release of CircuitPython for your board, check out the installation page \(https://adafru.it/Amd\)](https://adafru.it/Amd). You'll also need to load your code and reinstall your libraries!

For SAMD21 non-Express boards that have a UF2 bootloader:

Any SAMD21-based microcontroller that does not have external flash available is considered a SAMD21 non-Express board. Non-Express boards that have a UF2 bootloader include Trinket M0, GEMMA M0, QT Py M0, and the SAMD21-based Trinkey boards.

If you are trying to erase a SAMD21 non-Express board, follow these steps to erase your board.

1. Download the erase file:

SAMD21 non-Express Boards

<https://adafru.it/VB->

2. Double-click the reset button on the board to bring up the boardnameBOOT drive.
3. Drag the erase .uf2 file to the boardnameBOOT drive.
4. The boot LED will start flashing again, and the boardnameBOOT drive will reappear.
5. [Drag the appropriate latest release CircuitPython \(https://adafru.it/Em8\)](https://adafru.it/Em8) .uf2 file to the boardnameBOOT drive.

It should reboot automatically and you should see CIRCUITPY in your file explorer again.

[If you haven't already downloaded the latest release of CircuitPython for your board, check out the installation page \(https://adafru.it/Amd\)](https://adafru.it/Amd) YYou'll also need to load your code and reinstall your libraries!

For SAMD21 non-Express boards that do not have a UF2 bootloader:

Any SAMD21-based microcontroller that does not have external flash available is considered a SAMD21 non-Express board. Non-Express boards that do not have a

UF2 bootloaders include the Feather M0 Basic Proto, Feather Adalogger, or the Arduino Zero.

If you are trying to erase a non-Express board that does not have a UF2 bootloader, [follow these directions to reload CircuitPython using bossac](#) (<https://adafru.it/Bed>), which will erase and re-create CIRCUITPY.

Running Out of File Space on SAMD21 Non-Express Boards

Any SAMD21-based microcontroller that does not have external flash available is considered a SAMD21 non-Express board. This includes boards like the Trinket M0, GEMMA M0, QT Py M0, and the SAMD21-based Trinkey boards.

The file system on the board is very tiny. (Smaller than an ancient floppy disk.) So, it's likely you'll run out of space but don't panic! There are a number of ways to free up space.

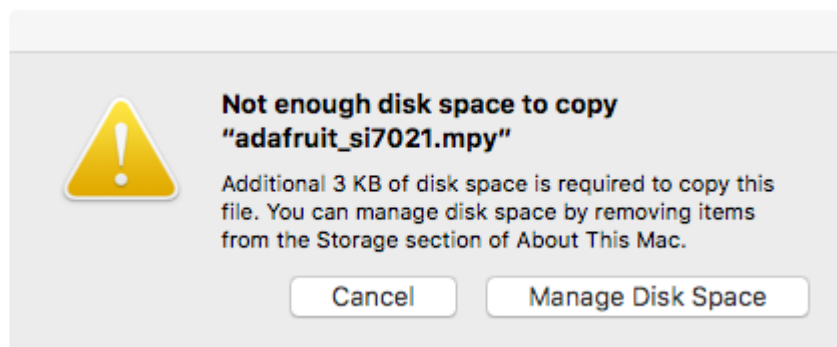

Delete something!

The simplest way of freeing up space is to delete files from the drive. Perhaps there are libraries in the lib folder that you aren't using anymore or test code that isn't in use. Don't delete the lib folder completely, though, just remove what you don't need.

The board ships with the Windows 7 serial driver too! Feel free to delete that if you don't need it or have already installed it. It's ~12KiB or so.

Use tabs

One unique feature of Python is that the indentation of code matters. Usually the recommendation is to indent code with four spaces for every indent. In general, that

is recommended too. However, one trick to storing more human-readable code is to use a single tab character for indentation. This approach uses 1/4 of the space for indentation and can be significant when you're counting bytes.

On MacOS?

MacOS loves to generate hidden files. Luckily you can disable some of the extra hidden files that macOS adds by running a few commands to disable search indexing and create zero byte placeholders. Follow the steps below to maximize the amount of space available on macOS.

Prevent & Remove MacOS Hidden Files

First find the volume name for your board. With the board plugged in run this command in a terminal to list all the volumes:

```
ls -l /Volumes
```

Look for a volume with a name like CIRCUITPY (the default for CircuitPython). The full path to the volume is the /Volumes/CIRCUITPY path.

Now follow the [steps from this question \(https://adafru.it/u1c\)](https://adafru.it/u1c) to run these terminal commands that stop hidden files from being created on the board:

```
mdutil -i off /Volumes/CIRCUITPY
cd /Volumes/CIRCUITPY
rm -rf .{,_.}{fsevents,Spotlight-V*,Trashes}
mkdir .fsevents
touch .fsevents/no_log .metadata_never_index .Trashes
cd -
```

Replace /Volumes/CIRCUITPY in the commands above with the full path to your board's volume if it's different. At this point all the hidden files should be cleared from the board and some hidden files will be prevented from being created.

Alternatively, with CircuitPython 4.x and above, the special files and folders mentioned above will be created automatically if you erase and reformat the filesystem. WARNING: Save your files first! Do this in the REPL:

```
>>> import storage
>>> storage.erase_filesystem()
```

However there are still some cases where hidden files will be created by MacOS. In particular if you copy a file that was downloaded from the internet it will have special metadata that MacOS stores as a hidden file. Luckily you can run a copy command from the terminal to copy files without this hidden metadata file. See the steps below.

Copy Files on MacOS Without Creating Hidden Files

Once you've disabled and removed hidden files with the above commands on macOS you need to be careful to copy files to the board with a special command that prevents future hidden files from being created. Unfortunately you cannot use drag and drop copy in Finder because it will still create these hidden extended attribute files in some cases (for files downloaded from the internet, like Adafruit's modules).

To copy a file or folder use the `-X` option for the `cp` command in a terminal. For example to copy a `file_name.mpy` file to the board use a command like:

```
cp -X file_name.mpy /Volumes/CIRCUITPY
```

(Replace `file_name.mpy` with the name of the file you want to copy.)

Or to copy a folder and all of the files and folders contained within, use a command like:

```
cp -rX folder_to_copy /Volumes/CIRCUITPY
```

If you are copying to the `lib` folder, or another folder, make sure it exists before copying.

```
# if lib does not exist, you'll create a file named lib !
cp -X file_name.mpy /Volumes/CIRCUITPY/lib
# This is safer, and will complain if a lib folder does not exist.
cp -X file_name.mpy /Volumes/CIRCUITPY/lib/
```

Other MacOS Space-Saving Tips

If you'd like to see the amount of space used on the drive and manually delete hidden files here's how to do so. First, move into the `Volumes/` directory with `cd /Volumes/`, and then list the amount of space used on the `CIRCUITPY` drive with the `df` command.

```
Default (-bash)
Last login: Thu Oct 28 17:19:15 on ttys008

7039 kattni@robocrepe:~ $ cd /Volumes/

7040 kattni@robocrepe:Volumes $ df -h CIRCUITPY/
Filesystem      Size  Used Avail Capacity  iused ifree %used  Mounted on
/dev/disk2s1    47Ki  46Ki  1.0Ki   98%     512    0 100%  /Volumes/CIRCUITPY

7041 kattni@robocrepe:Volumes $
```

That's not very much space left! The next step is to show a list of the files currently on the CIRCUITPY drive, including the hidden files, using the `ls` command. You cannot use Finder to do this, you must do it via command line!

```
7041 kattni@robocrepe:Volumes $ ls -a CIRCUITPY/
.          ._trinket_code.py  code.py
..         .fseventsd         lib
.Trashes   .idea              original_code.py
._code.py  .metadata_never_index trinket_code.py
._original_code.py boot_out.txt

7042 kattni@robocrepe:Volumes $
```

There are a few of the hidden files that MacOS loves to generate, all of which begin with a `._` before the file name. Remove the `._` files using the `rm` command. You can remove them all once by running `rm CIRCUITPY/._*`. The `*` acts as a wildcard to apply the command to everything that begins with `._` at the same time.

```
7042 kattni@robocrepe:Volumes $ rm CIRCUITPY/._*

7043 kattni@robocrepe:Volumes $
```

Finally, you can run `df` again to see the current space used.

```
7043 kattni@robocrepe:Volumes $ df -h CIRCUITPY/
Filesystem      Size  Used Avail Capacity  iused ifree %used  Mounted on
/dev/disk2s1    47Ki  34Ki  13Ki   73%     512    0 100%  /Volumes/CIRCUITPY

7044 kattni@robocrepe:Volumes $
```

Nice! You have 12Ki more than before! This space can now be used for libraries and code!

Device Locked Up or Boot Looping

In rare cases, it may happen that something in your `code.py` or `boot.py` files causes the device to get locked up, or even go into a boot loop. A boot loop occurs when the board reboots repeatedly and never fully loads. These are not caused by your everyday Python exceptions, typically it's the result of a deeper problem within CircuitPython. In this situation, it can be difficult to recover your device if CIRCUITPY is not allowing you to modify the `code.py` or `boot.py` files. Safe mode is one recovery

option. When the device boots up in safe mode it will not run the code.py or boot.py scripts, but will still connect the CIRCUITPY drive so that you can remove or modify those files as needed.

The method used to manually enter safe mode can be different for different devices. It is also very similar to the method used for getting into bootloader mode, which is a different thing. So it can take a few tries to get the timing right. If you end up in bootloader mode, no problem, you can try again without needing to do anything else.

For most devices:

Press the reset button, and then when the RGB status LED blinks yellow, press the reset button again. Since your reaction time may not be that fast, try a "slow" double click, to catch the yellow LED on the second click.

For ESP32-S2 based devices:

Press and release the reset button, then press and release the boot button about 3/4 of a second later.

Refer to the diagrams above for boot sequence details.

"Uninstalling" CircuitPython

A lot of our boards can be used with multiple programming languages. For example, the Circuit Playground Express can be used with MakeCode, Code.org CS Discoveries, CircuitPython and Arduino.

Maybe you tried CircuitPython and want to go back to MakeCode or Arduino? Not a problem. You can always remove or reinstall CircuitPython whenever you want! Heck, you can change your mind every day!

There is nothing to uninstall. CircuitPython is "just another program" that is loaded onto your board. You simply load another program (Arduino or MakeCode) and it will overwrite CircuitPython.

Backup Your Code

Before replacing CircuitPython, don't forget to make a backup of the code you have on the CIRCUITPY drive. That means your code.py any other files, the lib folder etc. You may lose these files when you remove CircuitPython, so backups are key! Just

drag the files to a folder on your laptop or desktop computer like you would with any USB drive.

Moving Circuit Playground Express to MakeCode

On the Circuit Playground Express (this currently does NOT apply to Circuit Playground Bluefruit), if you want to go back to using MakeCode, it's really easy. Visit [makecode.adafruit.com](https://adafruit.com/makecode) (<https://adafru.it/wpC>) and find the program you want to upload. Click Download to download the .uf2 file that is generated by MakeCode.

Now double-click your CircuitPython board until you see the onboard LED(s) turn green and the ...BOOT directory shows up.

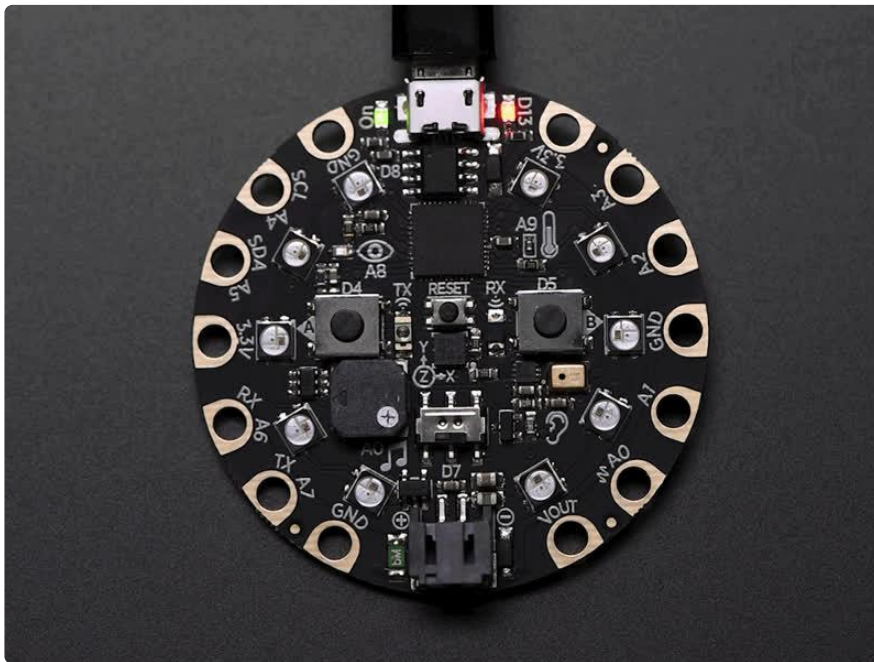

Then find the downloaded MakeCode .uf2 file and drag it to the CPLAYBOOT drive.

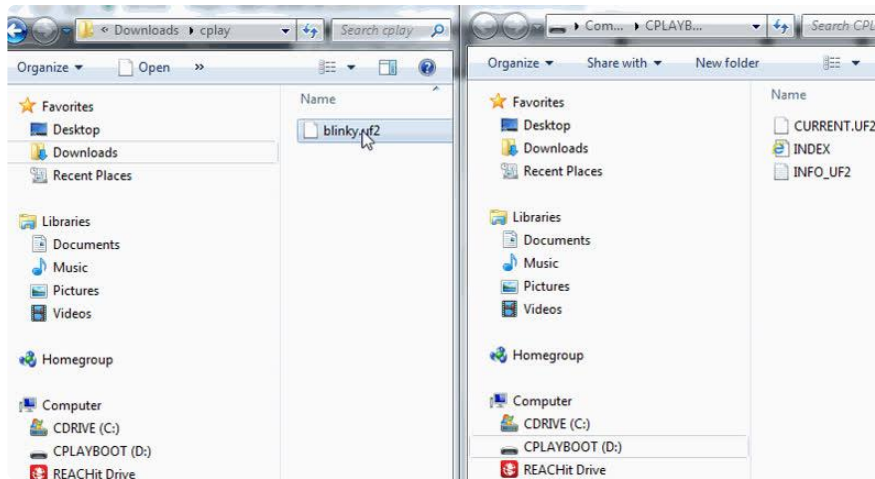

Your MakeCode is now running and CircuitPython has been removed. Going forward you only have to single click the reset button to get to CPLAYBOOT. This is an idiosyncrasy of MakeCode.

Moving to Arduino

If you want to use Arduino instead, you just use the Arduino IDE to load an Arduino program. Here's an example of uploading a simple "Blink" Arduino program, but you don't have to use this particular program.

Start by plugging in your board, and double-clicking reset until you get the green onboard LED(s).

Within Arduino IDE, select the matching board, say Circuit Playground Express.

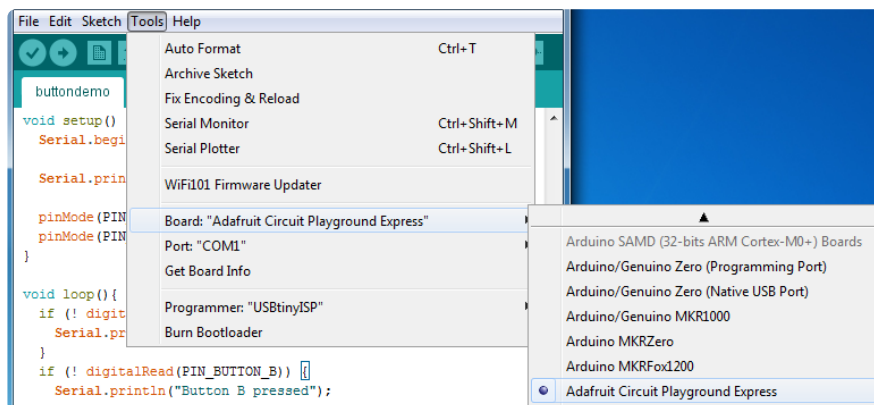

Select the correct matching Port:

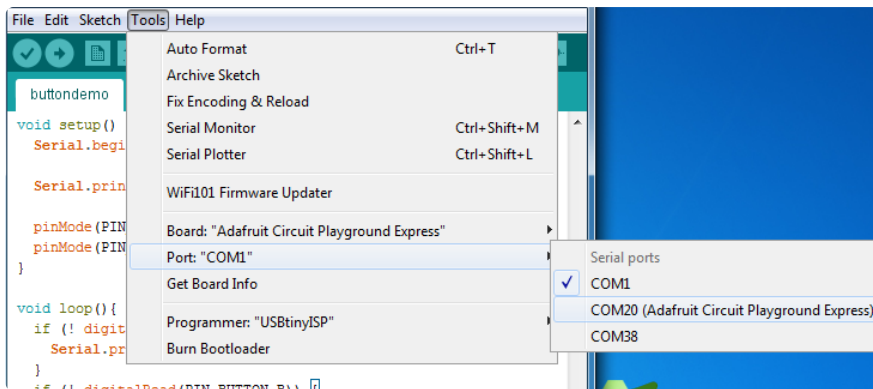

Create a new simple Blink sketch example:

```
// the setup function runs once when you press reset or power the board
void setup() {
  // initialize digital pin 13 as an output.
  pinMode(13, OUTPUT);
}

// the loop function runs over and over again forever
void loop() {
  digitalWrite(13, HIGH); // turn the LED on (HIGH is the voltage level)
  delay(1000);           // wait for a second
  digitalWrite(13, LOW); // turn the LED off by making the voltage LOW
  delay(1000);           // wait for a second
}
```

Make sure the LED(s) are still green, then click Upload to upload Blink. Once it has uploaded successfully, the serial Port will change so re-select the new Port!

Once Blink is uploaded you should no longer need to double-click to enter bootloader mode. Arduino will automatically reset when you upload.

Welcome to the Community!



CircuitPython is a programming language that's super simple to get started with and great for learning. It runs on microcontrollers and works out of the box. You can plug it in and get started with any text editor. The best part? CircuitPython comes with an amazing, supportive community.

Everyone is welcome! CircuitPython is Open Source. This means it's available for anyone to use, edit, copy and improve upon. This also means CircuitPython becomes better because of you being a part of it. Whether this is your first microcontroller board or you're a seasoned software engineer, you have something important to offer the Adafruit CircuitPython community. This page highlights some of the many ways you can be a part of it!

Adafruit Discord

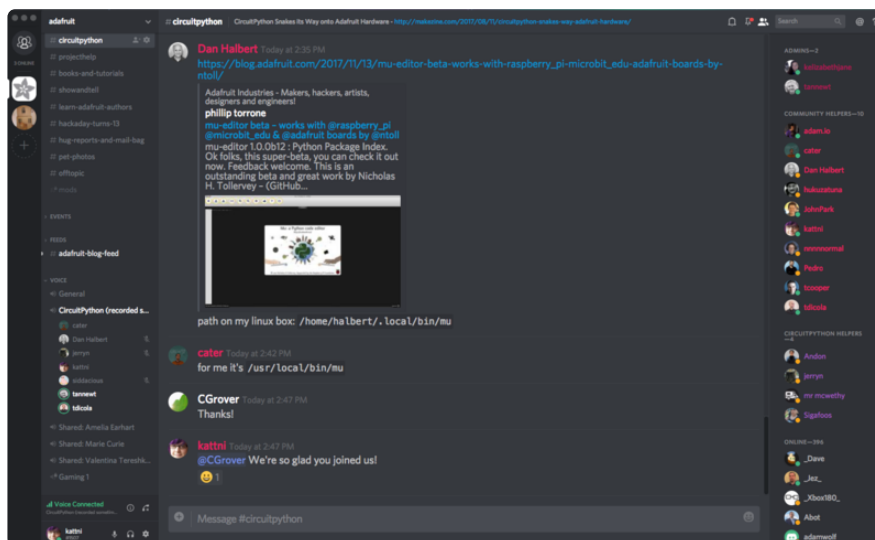

The Adafruit Discord server is the best place to start. Discord is where the community comes together to volunteer and provide live support of all kinds. From general discussion to detailed problem solving, and everything in between, Discord is a digital maker space with makers from around the world.

There are many different channels so you can choose the one best suited to your needs. Each channel is shown on Discord as "#channelname". There's the #help-with-projects channel for assistance with your current project or help coming up with ideas for your next one. There's the #show-and-tell channel for showing off your newest creation. Don't be afraid to ask a question in any channel! If you're unsure, #general is a great place to start. If another channel is more likely to provide you with a better answer, someone will guide you.

The help with CircuitPython channel is where to go with your CircuitPython questions. #help-with-circuitpython is there for new users and developers alike so feel free to ask a question or post a comment! Everyone of any experience level is welcome to join in on the conversation. Your contributions are important! The #circuitpython-dev channel is available for development discussions as well.

The easiest way to contribute to the community is to assist others on Discord. Supporting others doesn't always mean answering questions. Join in celebrating successes! Celebrate your mistakes! Sometimes just hearing that someone else has gone through a similar struggle can be enough to keep a maker moving forward.

The Adafruit Discord is the 24x7x365 hackerspace that you can bring your granddaughter to.

Visit <https://adafru.it/discord> () to sign up for Discord. Everyone is looking forward to meeting you!

CircuitPython.org

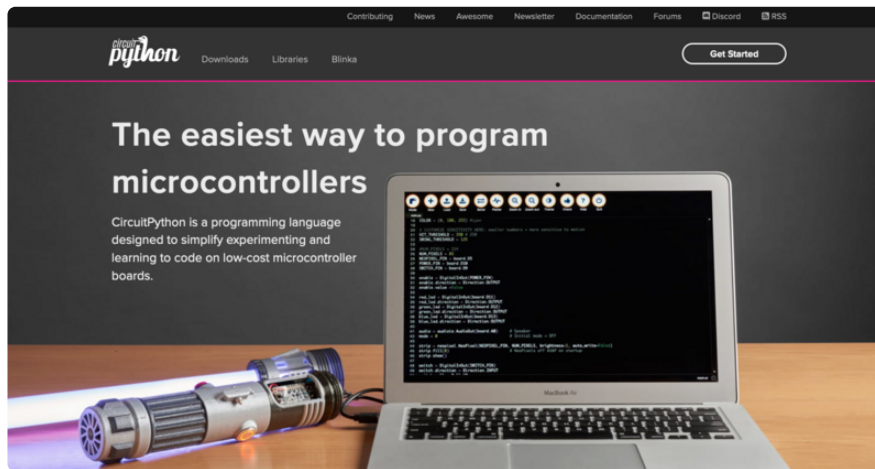

Beyond the Adafruit Learn System, which you are viewing right now, the best place to find information about CircuitPython is [circuitpython.org](https://adafru.it/KJD) (<https://adafru.it/KJD>). Everything you need to get started with your new microcontroller and beyond is available. You can do things like [download CircuitPython for your microcontroller](https://adafru.it/Em8) (<https://adafru.it/Em8>) or [download the latest CircuitPython Library bundle](https://adafru.it/ENC) (<https://adafru.it/ENC>), or check out [which single board computers support Blinka](https://adafru.it/EA8) (<https://adafru.it/EA8>). You can also get to various other CircuitPython related things like Awesome CircuitPython or the Python for Microcontrollers newsletter. This is all incredibly useful, but it isn't necessarily community related. So why is it included here? The [Contributing page](https://adafru.it/VD7) (<https://adafru.it/VD7>).

Contributing

If you'd like to contribute to the CircuitPython project, the CircuitPython libraries are a great way to begin. This page is updated with daily status information from the CircuitPython libraries, including open pull requests, open issues and library infrastructure issues.

Do you write a language other than English? Another great way to contribute to the project is to contribute new localizations (translations) of CircuitPython, or update current localizations, using [Weblate](#).

If this is your first time contributing, or you'd like to see our recommended contribution workflow, we have a guide on [Contributing to CircuitPython with Git and Github](#). You can also find us in the [#circuitpython](#) channel on the [Adafruit Discord](#).

Have an idea for a new driver or library? [File an issue on the CircuitPython repo!](#)

CircuitPython itself is written in C. However, all of the Adafruit CircuitPython libraries are written in Python. If you're interested in contributing to CircuitPython on the Python side of things, check out [circuitpython.org/contributing \(https://adafru.it/VD7\)](https://adafru.it/VD7). You'll find information pertaining to every Adafruit CircuitPython library GitHub repository, giving you the opportunity to join the community by finding a contributing option that works for you.

Note the date on the page next to Current Status for:

Current Status for Tue, Nov 02, 2021

If you submit any contributions to the libraries, and do not see them reflected on the Contributing page, it could be that the job that checks for new updates hasn't yet run for today. Simply check back tomorrow!

Now, a look at the different options.

Pull Requests

The first tab you'll find is a list of open pull requests.



Pull Requests **Open Issues** **Library Infrastructure Issues** **CircuitPython Localization**

This is the current status of open pull requests and issues across all of the library repos.

Open Pull Requests

- Adafuit_CircuitPython_AdafruitIO
 - [Call wifi.connect\(\) after wifi.reset\(\)](#) (Open 113 days)
- Adafuit_CircuitPython_ADS1x15
 - [Supress f-string recommendation in .pylintrc](#) (Open 1 days)
- Adafuit_CircuitPython_ADT7410
 - [Adding critical temp features](#) (Open 168 days)

GitHub pull requests, or PRs, are opened when folks have added something to an Adafruit CircuitPython library GitHub repo, and are asking for Adafruit to add, or merge, their changes into the main library code. For PRs to be merged, they must first be reviewed. Reviewing is a great way to contribute! Take a look at the list of open

pull requests, and pick one that interests you. If you have the hardware, you can test code changes. If you don't, you can still check the code updates for syntax. In the case of documentation updates, you can verify the information, or check it for spelling and grammar. Once you've checked out the update, you can leave a comment letting us know that you took a look. Once you've done that for a while, and you're more comfortable with it, you can consider joining the CircuitPythonLibrarians review team. The more reviewers we have, the more authors we can support. Reviewing is a crucial part of an open source ecosystem, CircuitPython included.

Open Issues

The second tab you'll find is a list of open issues.

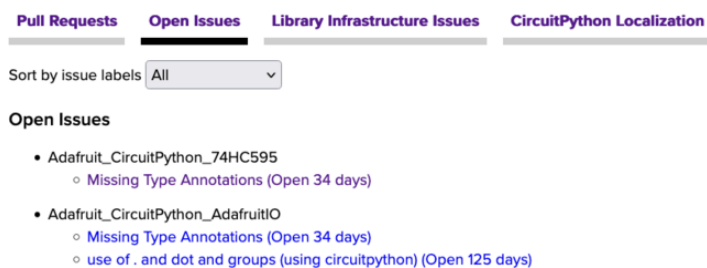

GitHub issues are filed for a number of reasons, including when there is a bug in the library or example code, or when someone wants to make a feature request. Issues are a great way to find an opportunity to contribute directly to the libraries by updating code or documentation. If you're interested in contributing code or documentation, take a look at the open issues and find one that interests you.

If you're not sure where to start, you can search the issues by label. Labels are applied to issues to make the goal easier to identify at a first glance, or to indicate the difficulty level of the issue. Click on the dropdown next to "Sort by issue labels" to see the list of available labels, and click on one to choose it.

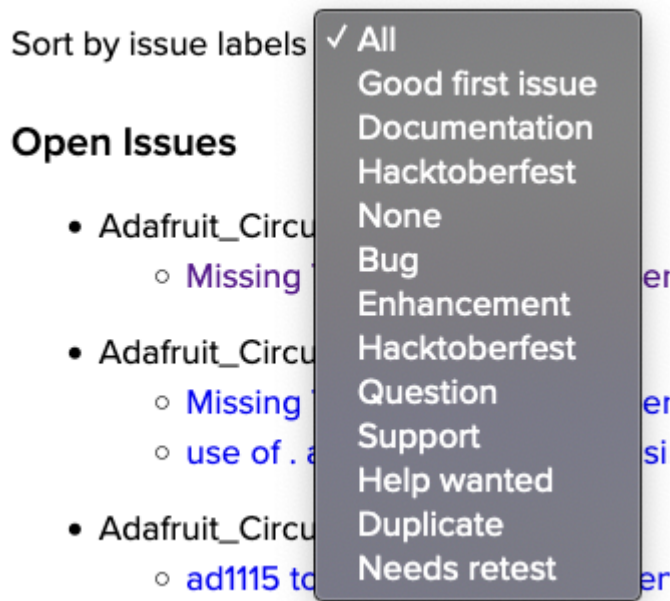

If you're new to everything, new to contributing to open source, or new to contributing to the CircuitPython project, you can choose "Good first issue". Issues with that label are well defined, with a finite scope, and are intended to be easy for someone new to figure out.

If you're looking for something a little more complicated, consider "Bug" or "Enhancement". The Bug label is applied to issues that pertain to problems or failures found in the library. The Enhancement label is applied to feature requests.

Don't let the process intimidate you. If you're new to Git and GitHub, there is [a guide \(https://adafru.it/Dkh\)](https://adafru.it/Dkh) to walk you through the entire process. As well, there are always folks available on [Discord \(\)](#) to answer questions.

Library Infrastructure Issues

The third tab you'll find is a list of library infrastructure issues.



This section is generated by a script that runs checks on the libraries, and then reports back where there may be issues. It is made up of a list of subsections each containing links to the repositories that are experiencing that particular issue. This page is available mostly for internal use, but you may find some opportunities to

contribute on this page. If there's an issue listed that sounds like something you could help with, mention it on Discord, or file an issue on GitHub indicating you're working to resolve that issue. Others can reply either way to let you know what the scope of it might be, and help you resolve it if necessary.

CircuitPython Localization

The fourth tab you'll find is the CircuitPython Localization tab.

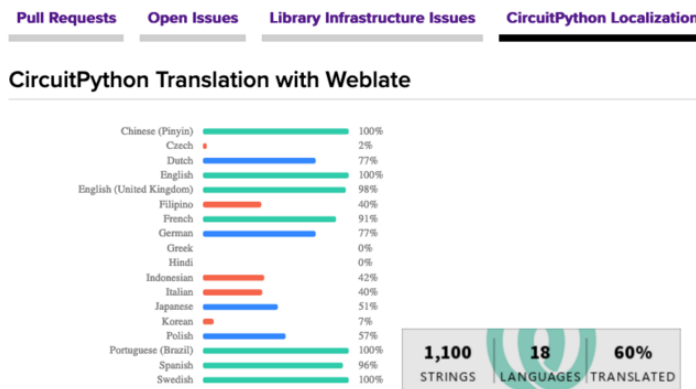

If you speak another language, you can help translate CircuitPython! The translations apply to informational and error messages that are within the CircuitPython core. It means that folks who do not speak English have the opportunity to have these messages shown to them in their own language when using CircuitPython. This is incredibly important to provide the best experience possible for all users.

CircuitPython uses Weblate to translate, which makes it much simpler to contribute translations. You will still need to know some CircuitPython-specific practices and a few basics about coding strings, but as with any CircuitPython contributions, folks are there to help.

Regardless of your skill level, or how you want to contribute to the CircuitPython project, there is an opportunity available. The [Contributing page \(https://adafru.it/VD7\)](https://adafru.it/VD7) is an excellent place to start!

Adafruit GitHub

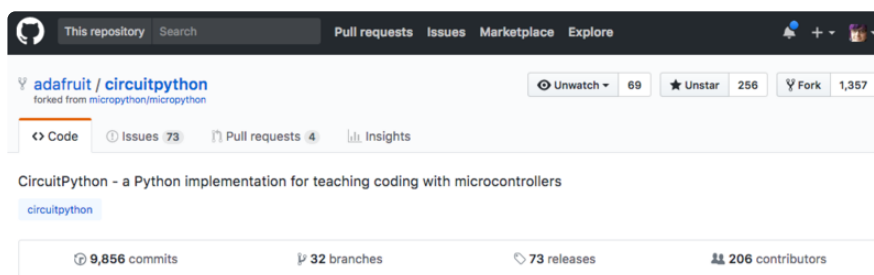

Whether you're just beginning or are life-long programmer who would like to contribute, there are ways for everyone to be a part of the CircuitPython project. The CircuitPython core is written in C. The libraries are written in Python. GitHub is the best source of ways to contribute to the [CircuitPython core \(https://adafru.it/tB7\)](https://adafru.it/tB7), and the [CircuitPython libraries \(https://adafru.it/VFv\)](https://adafru.it/VFv). If you need an account, visit <https://github.com/> (<https://adafru.it/d6C>) and sign up.

If you're new to GitHub or programming in general, there are great opportunities for you. For the CircuitPython core, head over to the CircuitPython repository on GitHub, click on "[Issues \(https://adafru.it/tBb\)](https://adafru.it/tBb)", and you'll find a list that includes issues labeled "[good first issue \(https://adafru.it/Bef\)](https://adafru.it/Bef)". For the libraries, head over to the [Contributing page Issues list \(https://adafru.it/VFv\)](https://adafru.it/VFv), and use the drop down menu to search for "[good first issue \(https://adafru.it/VFw\)](https://adafru.it/VFw)". These issues are things that have been identified as something that someone with any level of experience can help with. These issues include options like updating documentation, providing feedback, and fixing simple bugs. If you need help getting started with GitHub, there is an excellent guide on [Contributing to CircuitPython with Git and GitHub \(https://adafru.it/Dkh\)](https://adafru.it/Dkh).

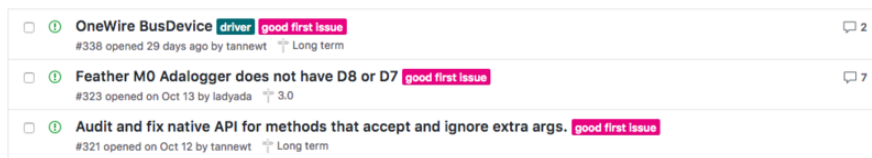

Already experienced and looking for a challenge? Checkout the rest of either issues list and you'll find plenty of ways to contribute. You'll find all sorts of things, from new driver requests, to library bugs, to core module updates. There's plenty of opportunities for everyone at any level!

When working with or using CircuitPython or the CircuitPython libraries, you may find problems. If you find a bug, that's great! The team loves bugs! Posting a detailed issue to GitHub is an invaluable way to contribute to improving CircuitPython. For CircuitPython itself, file an issue [here \(https://adafru.it/tBb\)](https://adafru.it/tBb). For the libraries, file an issue on the specific library repository on GitHub. Be sure to include the steps to replicate the issue as well as any other information you think is relevant. The more detail, the better!

Testing new software is easy and incredibly helpful. Simply load the newest version of CircuitPython or a library onto your CircuitPython hardware, and use it. Let us know about any problems you find by posting a new issue to GitHub. Software testing on both stable and unstable releases is a very important part of contributing CircuitPython. The developers can't possibly find all the problems themselves! They need your help to make CircuitPython even better.

On GitHub, you can submit feature requests, provide feedback, report problems and much more. If you have questions, remember that Discord and the Forums are both there for help!

Adafruit Forums

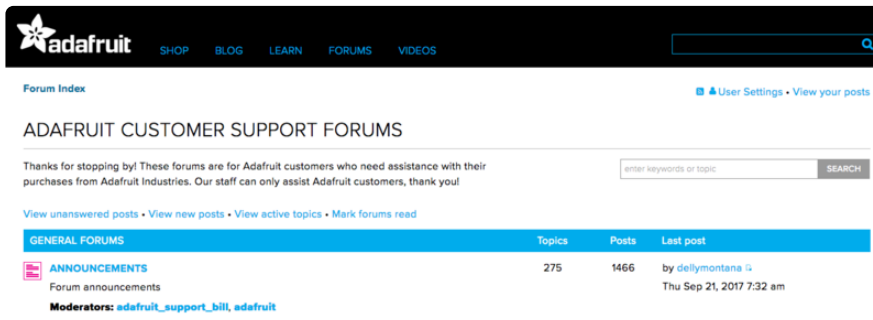

The [Adafruit Forums \(https://adafru.it/jlf\)](https://adafru.it/jlf) are the perfect place for support. Adafruit has wonderful paid support folks to answer any questions you may have. Whether your hardware is giving you issues or your code doesn't seem to be working, the forums are always there for you to ask. You need an Adafruit account to post to the forums. You can use the same account you use to order from Adafruit.

While Discord may provide you with quicker responses than the forums, the forums are a more reliable source of information. If you want to be certain you're getting an Adafruit-supported answer, the forums are the best place to be.

There are forum categories that cover all kinds of topics, including everything Adafruit. The [Adafruit CircuitPython \(https://adafru.it/xXA\)](https://adafru.it/xXA) category under "Supported Products & Projects" is the best place to post your CircuitPython questions.

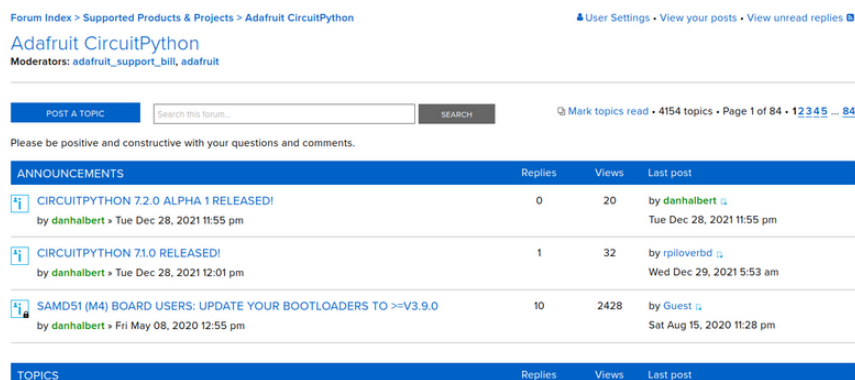

Be sure to include the steps you took to get to where you are. If it involves wiring, post a picture! If your code is giving you trouble, include your code in your post! These are great ways to make sure that there's enough information to help you with your issue.

You might think you're just getting started, but you definitely know something that someone else doesn't. The great thing about the forums is that you can help others too! Everyone is welcome and encouraged to provide constructive feedback to any of the posted questions. This is an excellent way to contribute to the community and share your knowledge!

Read the Docs

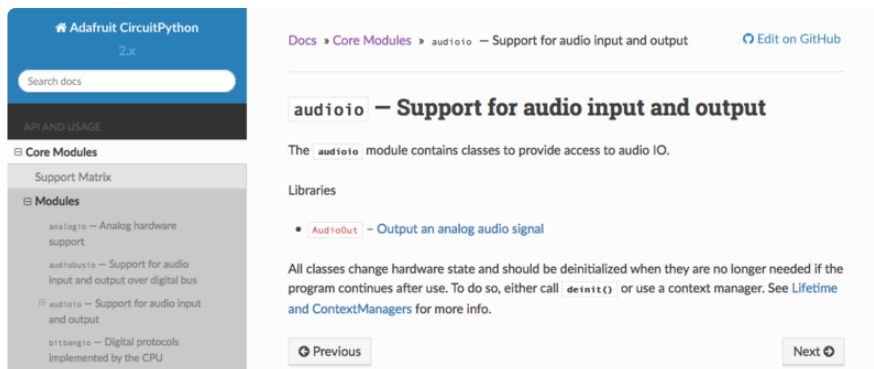

[Read the Docs \(https://adafru.it/Beg\)](https://adafru.it/Beg) is an excellent resource for a more detailed look at the CircuitPython core and the CircuitPython libraries. This is where you'll find things like API documentation and example code. For an in depth look at viewing and understanding Read the Docs, check out the [CircuitPython Documentation \(https://adafru.it/VFx\)](https://adafru.it/VFx) page!

Here is blinky:

```
import time
import digitalio
import board

led = digitalio.DigitalInOut(board.LED)
led.direction = digitalio.Direction.OUTPUT
while True:
    led.value = True
    time.sleep(0.1)
    led.value = False
    time.sleep(0.1)
```

PyPortal CircuitPython Setup

To use all the amazing features of your PyPortal with CircuitPython, you must first install a number of libraries. This page covers that process.

Adafruit CircuitPython Bundle

Download the Adafruit CircuitPython Library Bundle. You can find the latest release here:

Latest Adafruit CircuitPython Library Bundle

<https://adafru.it/ENC>

Download the `adafruit-circuitpython-bundle-*.x-mpy-*.zip` bundle zip file where `*.x` MATCHES THE VERSION OF CIRCUITPYTHON YOU INSTALLED, and unzip a folder of the same name. Inside you'll find a `lib` folder. You have two options:

- You can add the `lib` folder to your `CIRCUITPY` drive. This will ensure you have all the drivers. But it will take a bunch of space on the 8 MB disk
- Add each library as you need it, this will reduce the space usage but you'll need to put in a little more effort.

At a minimum we recommend the following libraries, in fact we more than recommend. They're basically required. So grab them and install them into `CIRCUITPY/lib` now!

- `adafruit_esp32spi` - This is the library that gives you internet access via the ESP32 using (you guessed it!) SPI transport. You need this for anything Internet
- `adafruit_requests` - This library allows us to perform HTTP requests and get responses back from servers. GET/POST/PUT/PATCH - they're all in here!
- `adafruit_pyportal` - This is our friendly wrapper library that does a lot of our projects, displays graphics and text, fetches data from the internet. Nearly all of our projects depend on it!
- `adafruit_portalbase` - This library is the base library that `adafruit_pyportal` library is built on top of.
- `adafruit_touchscreen` - a library for reading touches from the resistive touchscreen. Handles all the analog noodling, rotation and calibration for you.
- `adafruit_io` - this library helps connect the PyPortal to our free datalogging and viewing service
- `adafruit_imageload` - an image display helper, required for any graphics!
- `adafruit_display_text` - not surprisingly, it displays text on the screen
- `adafruit_bitmap_font` - we have fancy font support, and its easy to make new fonts. This library reads and parses font files.

- adafruit_slideshow - for making image slideshows - handy for quick display of graphics and sound
- neopixel - for controlling the onboard neopixel
- adafruit_adt7410 - library to read the temperature from the on-board Analog Devices ADT7410 precision temperature sensor (not necessary for Titano or Pynt)
- adafruit_bus_device - low level support for I2C/SPI
- adafruit_fakerequests - This library allows you to create fake HTTP requests by using local files.

Internet Connect!

Once you have CircuitPython setup and libraries installed we can get your board connected to the Internet. Note that access to enterprise level secured WiFi networks is not currently supported, only WiFi networks that require SSID and password.

To get connected, you will need to start by creating a secrets file.

What's a secrets file?

We expect people to share tons of projects as they build CircuitPython WiFi widgets. What we want to avoid is people accidentally sharing their passwords or secret tokens and API keys. So, we designed all our examples to use a `secrets.py` file, that is in your CIRCUITPY drive, to hold secret/private/custom data. That way you can share your main project without worrying about accidentally sharing private stuff.

Your secrets.py file should look like this:

```
# This file is where you keep secret settings, passwords, and tokens!
# If you put them in the code you risk committing that info or sharing it

secrets = {
    'ssid' : 'home ssid',
    'password' : 'my password',
    'timezone' : "America/New_York", # http://worldtimeapi.org/timezones
    'github_token' : 'fawfj23rakjnfawiefafa',
    'hackaday_token' : 'h4xx0rs3kret',
}
```

Inside is a python dictionary named secrets with a line for each entry. Each entry has an entry name (say `'ssid'`) and then a colon to separate it from the entry key `'home ssid'` and finally a comma ,

At a minimum you'll need the `ssid` and `password` for your local WiFi setup. As you make projects you may need more tokens and keys, just add them one line at a time. See for example other tokens such as one for accessing github or the hackaday API. Other non-secret data like your timezone can also go here, just cause it's called secrets doesn't mean you can't have general customization data in there!

For the correct time zone string, look at <http://worldtimeapi.org/timezones> (<https://adafru.it/EcP>) and remember that if your city is not listed, look for a city in the same time zone, for example Boston, New York, Philadelphia, Washington DC, and Miami are all on the same time as New York.

Of course, don't share your secrets.py - keep that out of GitHub, Discord or other project-sharing sites.

Connect to WiFi

OK now you have your secrets setup - you can connect to the Internet. Lets use the ESP32SPI and the Requests libraries - [you'll need to visit the CircuitPython bundle and install \(https://adafru.it/ENC\)](https://adafru.it/ENC):

- `adafruit_bus_device`
- `adafruit_esp32spi`
- `adafruit_requests`
- `neopixel`

Into your `lib` folder. Once that's done, load up the following example using Mu or your favorite editor:

```
# SPDX-FileCopyrightText: 2019 ladyada for Adafruit Industries
# SPDX-License-Identifier: MIT

import board
import busio
from digitalio import DigitalInOut
import adafruit_requests as requests
import adafruit_esp32spi.adafruit_esp32spi_socket as socket
from adafruit_esp32spi import adafruit_esp32spi

# Get wifi details and more from a secrets.py file
try:
    from secrets import secrets
except ImportError:
    print("WiFi secrets are kept in secrets.py, please add them there!")
    raise

print("ESP32 SPI webclient test")

TEXT_URL = "http://wifitest.adafruit.com/testwifi/index.html"
```

```

JSON_URL = "http://api.coindesk.com/v1/bpi/currentprice/USD.json"

# If you are using a board with pre-defined ESP32 Pins:
esp32_cs = DigitalInOut(board.ESP_CS)
esp32_ready = DigitalInOut(board.ESP_BUSY)
esp32_reset = DigitalInOut(board.ESP_RESET)

# If you have an AirLift Shield:
# esp32_cs = DigitalInOut(board.D10)
# esp32_ready = DigitalInOut(board.D7)
# esp32_reset = DigitalInOut(board.D5)

# If you have an AirLift Featherwing or ItsyBitsy AirLift:
# esp32_cs = DigitalInOut(board.D13)
# esp32_ready = DigitalInOut(board.D11)
# esp32_reset = DigitalInOut(board.D12)

# If you have an externally connected ESP32:
# NOTE: You may need to change the pins to reflect your wiring
# esp32_cs = DigitalInOut(board.D9)
# esp32_ready = DigitalInOut(board.D10)
# esp32_reset = DigitalInOut(board.D5)

spi = busio.SPI(board.SCK, board.MOSI, board.MISO)
esp = adafruit_esp32spi.ESP_SPIcontrol(spi, esp32_cs, esp32_ready, esp32_reset)

requests.set_socket(socket, esp)

if esp.status == adafruit_esp32spi.WL_IDLE_STATUS:
    print("ESP32 found and in idle mode")
print("Firmware vers.", esp.firmware_version)
print("MAC addr:", [hex(i) for i in esp.MAC_address])

for ap in esp.scan_networks():
    print("\t%s\t\tRSSI: %d" % (str(ap["ssid"], "utf-8"), ap["rssi"]))

print("Connecting to AP...")
while not esp.is_connected:
    try:
        esp.connect_AP(secrets["ssid"], secrets["password"])
    except OSError as e:
        print("could not connect to AP, retrying: ", e)
        continue
print("Connected to", str(esp.ssid, "utf-8"), "\tRSSI:", esp.rssi)
print("My IP address is", esp.pretty_ip(esp.ip_address))
print(
    "IP lookup adafruit.com: %s" %
    esp.pretty_ip(esp.get_host_by_name("adafruit.com"))
)
print("Ping google.com: %d ms" % esp.ping("google.com"))

# esp._debug = True
print("Fetching text from", TEXT_URL)
r = requests.get(TEXT_URL)
print("-" * 40)
print(r.text)
print("-" * 40)
r.close()

print()
print("Fetching json from", JSON_URL)
r = requests.get(JSON_URL)
print("-" * 40)
print(r.json())
print("-" * 40)
r.close()

print("Done!")

```

And save it to your board, with the name `code.py`.

Don't forget you'll also need to create the `secrets.py` file as seen above, with your WiFi ssid and password.

In a serial console, you should see something like the following. For more information about connecting with a serial console, view the guide [Connecting to the Serial Console \(https://adafru.it/Bec\)](https://adafru.it/Bec).

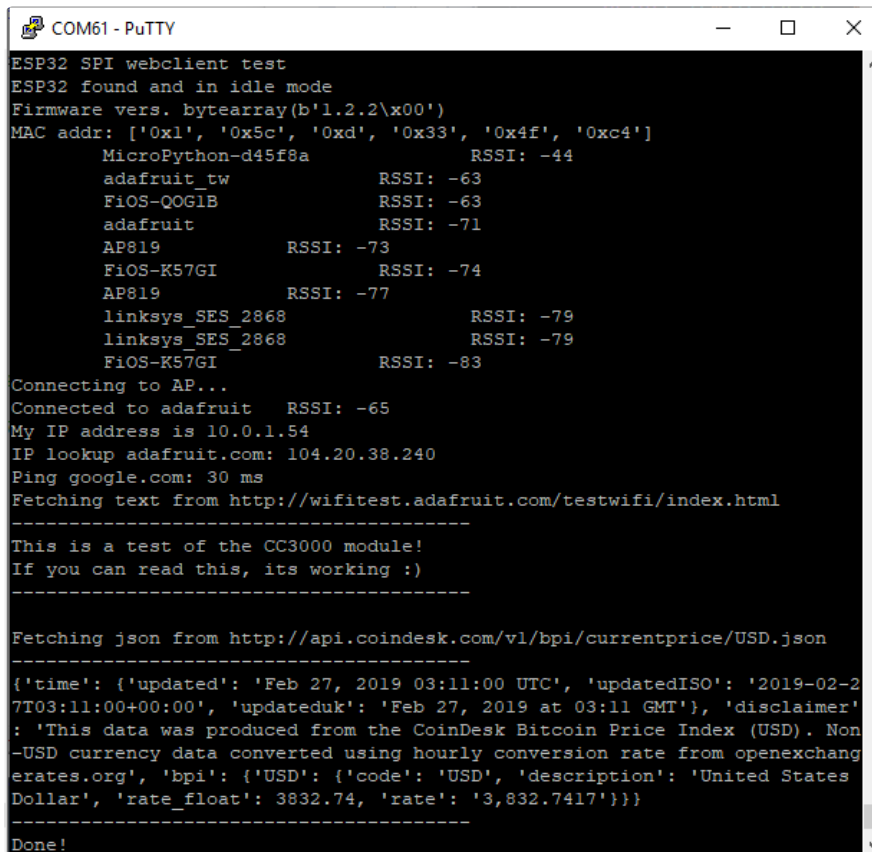

```
COM61 - PuTTY
ESP32 SPI webclient test
ESP32 found and in idle mode
Firmware vers. bytearray(b'1.2.2\x00')
MAC addr: ['0x1', '0x5c', '0xd', '0x33', '0x4f', '0xc4']
MicroPython-d45f8a          RSSI: -44
adafruit_tw                 RSSI: -63
FiOS-QOGLB                  RSSI: -63
adafruit                    RSSI: -71
AP819                       RSSI: -73
FiOS-K57GI                  RSSI: -74
AP819                       RSSI: -77
linksys_SES_2868            RSSI: -79
linksys_SES_2868            RSSI: -79
FiOS-K57GI                  RSSI: -83
Connecting to AP...
Connected to adafruit        RSSI: -65
My IP address is 10.0.1.54
IP lookup adafruit.com: 104.20.38.240
Ping google.com: 30 ms
Fetching text from http://wifitest.adafruit.com/testwifi/index.html
-----
This is a test of the CC3000 module!
If you can read this, its working :)
-----
Fetching json from http://api.coindesk.com/v1/bpi/currentprice/USD.json
-----
{'time': {'updated': 'Feb 27, 2019 03:11:00 UTC', 'updatedISO': '2019-02-27T03:11:00+00:00', 'updateduk': 'Feb 27, 2019 at 03:11 GMT'}, 'disclaimer': 'This data was produced from the CoinDesk Bitcoin Price Index (USD). Non-USD currency data converted using hourly conversion rate from openexchangerates.org', 'bpi': {'USD': {'code': 'USD', 'description': 'United States Dollar', 'rate_float': 3832.74, 'rate': '3,832.7417'}}}
-----
Done!
```

In order, the example code...

Initializes the ESP32 over SPI using the SPI port and 3 control pins:

```
esp32_cs = DigitalInOut(board.ESP_CS)
esp32_ready = DigitalInOut(board.ESP_BUSY)
esp32_reset = DigitalInOut(board.ESP_RESET)

spi = busio.SPI(board.SCK, board.MOSI, board.MISO)
esp = adafruit_esp32spi.ESP_SPIcontrol(spi, esp32_cs, esp32_ready, esp32_reset)
```

Tells our `requests` library the type of socket we're using (socket type varies by connectivity type - we'll be using the `adafruit_esp32spi_socket` for this example). We'll also set the interface to an `esp` object. This is a little bit of a hack, but it lets us use `requests` like CPython does.

```
requests.set_socket(socket, esp)
```

Verifies an ESP32 is found, checks the firmware and MAC address

```
if esp.status == adafruit_esp32spi.WL_IDLE_STATUS:
    print("ESP32 found and in idle mode")
print("Firmware vers.", esp.firmware_version)
print("MAC addr:", [hex(i) for i in esp.MAC_address])
```

Performs a scan of all access points it can see and prints out the name and signal strength:

```
for ap in esp.scan_networks():
    print("\t%s\t\tRSSI: %d" % (str(ap['ssid'], 'utf-8'), ap['rssi']))
```

Connects to the AP we've defined here, then prints out the local IP address, attempts to do a domain name lookup and ping google.com to check network connectivity (note sometimes the ping fails or takes a while, this isn't a big deal)

```
print("Connecting to AP...")
while not esp.is_connected:
    try:
        esp.connect_AP(secrets["ssid"], secrets["password"])
    except RuntimeError as e:
        print("could not connect to AP, retrying: ", e)
        continue
print("Connected to", str(esp.ssid, "utf-8"), "\tRSSI:", esp.rssi)
print("My IP address is", esp.pretty_ip(esp.ip_address))
print(
    "IP lookup adafruit.com: %s" %
    esp.pretty_ip(esp.get_host_by_name("adafruit.com")))
```

OK now we're getting to the really interesting part. With a SAMD51 or other large-RAM (well, over 32 KB) device, we can do a lot of neat tricks. Like for example we can implement an interface a lot like [requests](https://adafru.it/E9o) (<https://adafru.it/E9o>) - which makes getting data really really easy

To read in all the text from a web URL call `requests.get` - you can pass in `https` URLs for SSL connectivity

```
TEXT_URL = "http://wifitest.adafruit.com/testwifi/index.html"
print("Fetching text from", TEXT_URL)
r = requests.get(TEXT_URL)
print('- '*40)
print(r.text)
print('- '*40)
r.close()
```

Or, if the data is in structured JSON, you can get the json pre-parsed into a Python dictionary that can be easily queried or traversed. (Again, only for nRF52840, M4 and other high-RAM boards)

```
JSON_URL = "http://api.coindesk.com/v1/bpi/currentprice/USD.json"
print("Fetching json from", JSON_URL)
r = requests.get(JSON_URL)
print('-'*40)
print(r.json())
print('-'*40)
r.close()
```

Requests

We've written a [requests-like \(https://adafru.it/Kpa\)](https://adafru.it/Kpa) library for web interfacing named [Adafruit_CircuitPython_Requests \(https://adafru.it/FpW\)](https://adafru.it/FpW). This library allows you to send HTTP/1.1 requests without "crafting" them and provides helpful methods for parsing the response from the server.

```
# SPDX-FileCopyrightText: 2021 ladyada for Adafruit Industries
# SPDX-License-Identifier: MIT

# adafruit_requests usage with an esp32spi_socket
import board
import busio
from digitalio import DigitalInOut
import adafruit_esp32spi.adafruit_esp32spi_socket as socket
from adafruit_esp32spi import adafruit_esp32spi
import adafruit_requests as requests

# Add a secrets.py to your filesystem that has a dictionary called secrets with
"ssid" and
# "password" keys with your WiFi credentials. DO NOT share that file or commit it
into Git or other
# source control.
# pylint: disable=no-name-in-module,wrong-import-order
try:
    from secrets import secrets
except ImportError:
    print("WiFi secrets are kept in secrets.py, please add them there!")
    raise

# If you are using a board with pre-defined ESP32 Pins:
esp32_cs = DigitalInOut(board.ESP_CS)
esp32_ready = DigitalInOut(board.ESP_BUSY)
esp32_reset = DigitalInOut(board.ESP_RESET)

# If you have an externally connected ESP32:
# esp32_cs = DigitalInOut(board.D9)
# esp32_ready = DigitalInOut(board.D10)
# esp32_reset = DigitalInOut(board.D5)

# If you have an AirLift Featherwing or ItsyBitsy AirLift:
# esp32_cs = DigitalInOut(board.D13)
# esp32_ready = DigitalInOut(board.D11)
# esp32_reset = DigitalInOut(board.D12)

spi = busio.SPI(board.SCK, board.MOSI, board.MISO)
```

```

esp = adafruit_esp32spi.ESP_SPIcontrol(spi, esp32_cs, esp32_ready, esp32_reset)

print("Connecting to AP...")
while not esp.is_connected:
    try:
        esp.connect_AP(secrets["ssid"], secrets["password"])
    except RuntimeError as e:
        print("could not connect to AP, retrying: ", e)
        continue
print("Connected to", str(esp.ssid, "utf-8"), "\tRSSI:", esp.rssi)

# Initialize a requests object with a socket and esp32spi interface
socket.set_interface(esp)
requests.set_socket(socket, esp)

TEXT_URL = "http://wifitest.adafruit.com/testwifi/index.html"
JSON_GET_URL = "https://httpbin.org/get"
JSON_POST_URL = "https://httpbin.org/post"

print("Fetching text from %s" % TEXT_URL)
response = requests.get(TEXT_URL)
print("-" * 40)

print("Text Response: ", response.text)
print("-" * 40)
response.close()

print("Fetching JSON data from %s" % JSON_GET_URL)
response = requests.get(JSON_GET_URL)
print("-" * 40)

print("JSON Response: ", response.json())
print("-" * 40)
response.close()

data = "31F"
print("POSTing data to {0}: {1}".format(JSON_POST_URL, data))
response = requests.post(JSON_POST_URL, data=data)
print("-" * 40)

json_resp = response.json()
# Parse out the 'data' key from json_resp dict.
print("Data received from server:", json_resp["data"])
print("-" * 40)
response.close()

json_data = {"Date": "July 25, 2019"}
print("POSTing data to {0}: {1}".format(JSON_POST_URL, json_data))
response = requests.post(JSON_POST_URL, json=json_data)
print("-" * 40)

json_resp = response.json()
# Parse out the 'json' key from json_resp dict.
print("JSON Data received from server:", json_resp["json"])
print("-" * 40)
response.close()

```

The code first sets up the ESP32SPI interface. Then, it initializes a `request` object using an ESP32 `socket` and the `esp` object.

```

import board
import busio
from digitalio import DigitalInOut
import adafruit_esp32spi.adafruit_esp32spi_socket as socket
from adafruit_esp32spi import adafruit_esp32spi
import adafruit_requests as requests

```

```

# If you are using a board with pre-defined ESP32 Pins:
esp32_cs = DigitalInOut(board.ESP_CS)
esp32_ready = DigitalInOut(board.ESP_BUSY)
esp32_reset = DigitalInOut(board.ESP_RESET)

# If you have an externally connected ESP32:
# esp32_cs = DigitalInOut(board.D9)
# esp32_ready = DigitalInOut(board.D10)
# esp32_reset = DigitalInOut(board.D5)

spi = busio.SPI(board.SCK, board.MOSI, board.MISO)
esp = adafruit_esp32spi.ESP_SPIcontrol(spi, esp32_cs, esp32_ready, esp32_reset)

print("Connecting to AP...")
while not esp.is_connected:
    try:
        esp.connect_AP(b'MY_SSID_NAME', b'MY_SSID_PASSWORD')
    except RuntimeError as e:
        print("could not connect to AP, retrying: ",e)
        continue
print("Connected to", str(esp.ssid, 'utf-8'), "\tRSSI:", esp.rssi)

# Initialize a requests object with a socket and esp32spi interface
requests.set_socket(socket, esp)

```

HTTP GET with Requests

The code makes a HTTP GET request to Adafruit's WiFi testing website - <http://wifitest.adafruit.com/testwifi/index.html> (<https://adafru.it/Fp->).

To do this, we'll pass the URL into `requests.get()`. We're also going to save the response from the server into a variable named `response`.

Having requested data from the server, we'd now like to see what the server responded with. Since we already saved the server's `response`, we can read it back. Luckily for us, requests automatically decodes the server's response into human-readable text, you can read it back by calling `response.text`.

Lastly, we'll perform a bit of cleanup by calling `response.close()`. This closes, deletes, and collect's the response's data.

```

print("Fetching text from %s"%TEXT_URL)
response = requests.get(TEXT_URL)
print('- '*40)

print("Text Response: ", response.text)
print('- '*40)
response.close()

```

While some servers respond with text, some respond with json-formatted data consisting of attribute–value pairs.

CircuitPython_Requests can convert a JSON-formatted response from a server into a CPython **dict** object.

We can also fetch and parse json data. We'll send a HTTP get to a url we know returns a json-formatted response (instead of text data).

Then, the code calls **response.json()** to convert the response to a CPython **dict**.

```
print("Fetching JSON data from %s"%JSON_GET_URL)
response = requests.get(JSON_GET_URL)
print('- '*40)

print("JSON Response: ", response.json())
print('- '*40)
response.close()
```

HTTP POST with Requests

Requests can also POST data to a server by calling the **requests.post** method, passing it a **data** value.

```
data = '31F'
print("POSTing data to {0}: {1}".format(JSON_POST_URL, data))
response = requests.post(JSON_POST_URL, data=data)
print('- '*40)

json_resp = response.json()
# Parse out the 'data' key from json_resp dict.
print("Data received from server:", json_resp['data'])
print('- '*40)
response.close()
```

You can also post json-formatted data to a server by passing **json_data** into the **requests.post** method.

```
json_data = {"Date" : "July 25, 2019"}
print("POSTing data to {0}: {1}".format(JSON_POST_URL, json_data))
response = requests.post(JSON_POST_URL, json=json_data)
print('- '*40)

json_resp = response.json()
# Parse out the 'json' key from json_resp dict.
print("JSON Data received from server:", json_resp['json'])
print('- '*40)
response.close()
```

Advanced Requests Usage

Want to send custom HTTP headers, parse the response as raw bytes, or handle a response's http status code in your CircuitPython code?

We've written an example to show advanced usage of the requests module below.

```
# SPDX-FileCopyrightText: 2021 ladyada for Adafruit Industries
# SPDX-License-Identifier: MIT

import board
import busio
from digitalio import DigitalInOut
import adafruit_esp32spi.adafruit_esp32spi_socket as socket
from adafruit_esp32spi import adafruit_esp32spi
import adafruit_requests as requests

# Add a secrets.py to your filesystem that has a dictionary called secrets with
"ssid" and
# "password" keys with your WiFi credentials. DO NOT share that file or commit it
into Git or other
# source control.
# pylint: disable=no-name-in-module,wrong-import-order
try:
    from secrets import secrets
except ImportError:
    print("WiFi secrets are kept in secrets.py, please add them there!")
    raise

# If you are using a board with pre-defined ESP32 Pins:
esp32_cs = DigitalInOut(board.ESP_CS)
esp32_ready = DigitalInOut(board.ESP_BUSY)
esp32_reset = DigitalInOut(board.ESP_RESET)

# If you have an externally connected ESP32:
# esp32_cs = DigitalInOut(board.D9)
# esp32_ready = DigitalInOut(board.D10)
# esp32_reset = DigitalInOut(board.D5)

spi = busio.SPI(board.SCK, board.MOSI, board.MISO)
esp = adafruit_esp32spi.ESP_SPIcontrol(spi, esp32_cs, esp32_ready, esp32_reset)

print("Connecting to AP...")
while not esp.is_connected:
    try:
        esp.connect_AP(secrets["ssid"], secrets["password"])
    except RuntimeError as e:
        print("could not connect to AP, retrying: ", e)
        continue
print("Connected to", str(esp.ssid, "utf-8"), "\tRSSI:", esp.rssi)

# Initialize a requests object with a socket and esp32spi interface
socket.set_interface(esp)
requests.set_socket(socket, esp)

JSON_GET_URL = "http://httpbin.org/get"

# Define a custom header as a dict.
headers = {"user-agent": "blinka/1.0.0"}

print("Fetching JSON data from %s..." % JSON_GET_URL)
response = requests.get(JSON_GET_URL, headers=headers)
print("-" * 60)
```

```

json_data = response.json()
headers = json_data["headers"]
print("Response's Custom User-Agent Header: {0}".format(headers["User-Agent"]))
print("-" * 60)

# Read Response's HTTP status code
print("Response HTTP Status Code: ", response.status_code)
print("-" * 60)

# Close, delete and collect the response data
response.close()

```

WiFi Manager

That simplest example works but it's a little finicky - you need to constantly check WiFi status and have many loops to manage connections and disconnections. For more advanced uses, we recommend using the WiFiManager object. It will wrap the connection/status/requests loop for you - reconnecting if WiFi drops, resetting the ESP32 if it gets into a bad state, etc.

Here's a more advanced example that shows the WiFi manager and also how to POST data with some extra headers:

```

# SPDX-FileCopyrightText: 2019 ladyada for Adafruit Industries
# SPDX-License-Identifier: MIT

import time
import board
import busio
from digitalio import DigitalInOut
import neopixel
from adafruit_esp32spi import adafruit_esp32spi
from adafruit_esp32spi import adafruit_esp32spi_wifimanager

print("ESP32 SPI webclient test")

# Get wifi details and more from a secrets.py file
try:
    from secrets import secrets
except ImportError:
    print("WiFi secrets are kept in secrets.py, please add them there!")
    raise

# If you are using a board with pre-defined ESP32 Pins:
esp32_cs = DigitalInOut(board.ESP_CS)
esp32_ready = DigitalInOut(board.ESP_BUSY)
esp32_reset = DigitalInOut(board.ESP_RESET)

# If you have an externally connected ESP32:
# esp32_cs = DigitalInOut(board.D9)
# esp32_ready = DigitalInOut(board.D10)
# esp32_reset = DigitalInOut(board.D5)

spi = busio.SPI(board.SCK, board.MOSI, board.MISO)
esp = adafruit_esp32spi.ESP_SPIcontrol(spi, esp32_cs, esp32_ready, esp32_reset)
"""Use below for Most Boards"""
status_light = neopixel.NeoPixel(
    board.NEOPIXEL, 1, brightness=0.2

```

```

) # Uncomment for Most Boards
"""Uncomment below for ItsyBitsy M4"""
# status_light = dotstar.DotStar(board.APA102_SCK, board.APA102_MOSI, 1,
brightness=0.2)
# Uncomment below for an externally defined RGB LED
# import adafruit_rgbled
# from adafruit_esp32spi import PWMOut
# RED_LED = PWMOut.PWMOut(esp, 26)
# GREEN_LED = PWMOut.PWMOut(esp, 27)
# BLUE_LED = PWMOut.PWMOut(esp, 25)
# status_light = adafruit_rgbled.RGBLED(RED_LED, BLUE_LED, GREEN_LED)
wifi = adafruit_esp32spi_wifimanager.ESPSPI_WiFiManager(esp, secrets, status_light)

counter = 0

while True:
    try:
        print("Posting data...", end="")
        data = counter
        feed = "test"
        payload = {"value": data}
        response = wifi.post(
            "https://io.adafruit.com/api/v2/"
            + secrets["aio_username"]
            + "/feeds/"
            + feed
            + "/data",
            json=payload,
            headers={"X-AIO-KEY": secrets["aio_key"]},
        )
        print(response.json())
        response.close()
        counter = counter + 1
        print("OK")
    except OSError as e:
        print("Failed to get data, retrying\n", e)
        wifi.reset()
        continue
    response = None
    time.sleep(15)

```

You'll note here we use a secrets.py file to manage our SSID info. The wifimanager is given the ESP32 object, secrets and a neopixel for status indication.

Note, you'll need to add a some additional information to your secrets file so that the code can query the Adafruit IO API:

- aio_username
- aio_key

You can go to your adafruit.io View AIO Key link to get those two values and add them to the secrets file, which will now look something like this:

```

# This file is where you keep secret settings, passwords, and tokens!
# If you put them in the code you risk committing that info or sharing it

secrets = {
    'ssid' : '_your_ssid_',
    'password' : '_your_wifi_password_',

```

```
'timezone' : "America/Los_Angeles", # http://worldtimeapi.org/timezones
'aio_username' : '_your_aio_username_',
'aio_key' : '_your_aio_key_',
}
```

Next, set up an Adafruit IO feed named **test**

- If you do not know how to set up a feed, [follow this page and come back when you've set up a feed named **test**](https://adafru.it/f5k). (<https://adafru.it/f5k>)

We can then have a simple loop for posting data to Adafruit IO without having to deal with connecting or initializing the hardware!

Take a look at your test feed on Adafruit.io and you'll see the value increase each time the CircuitPython board posts data to it!



Arduino IDE Setup

The first thing you will need to do is to download the latest release of the Arduino IDE. You will need to be using version 1.8 or higher for this guide

Arduino IDE Download

<https://adafru.it/f1P>

After you have downloaded and installed the latest version of Arduino IDE, you will need to start the IDE and navigate to the Preferences menu. You can access it from the File menu in Windows or Linux, or the Arduino menu on OS X.

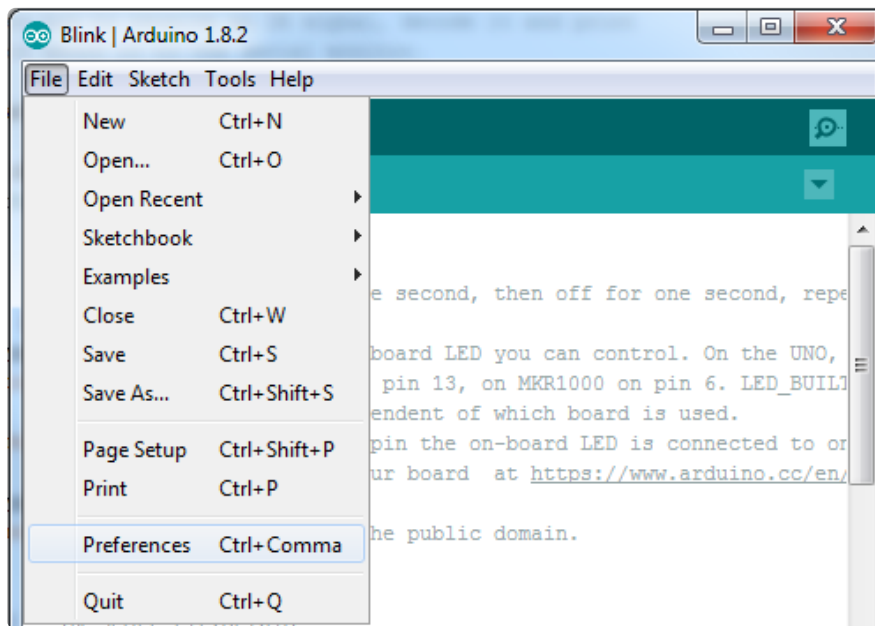

A dialog will pop up just like the one shown below.

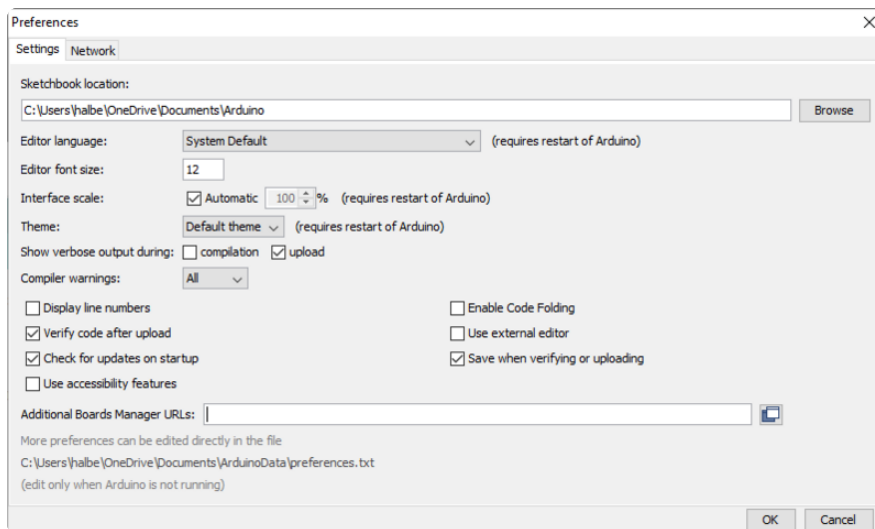

We will be adding a URL to the new Additional Boards Manager URLs option. The list of URLs is comma separated, and you will only have to add each URL once. New Adafruit boards and updates to existing boards will automatically be picked up by the Board Manager each time it is opened. The URLs point to index files that the Board Manager uses to build the list of available & installed boards.

To find the most up to date list of URLs you can add, you can visit the list of [third party board URLs on the Arduino IDE wiki \(https://adafru.it/f7U\)](https://adafru.it/f7U). We will only need to add one URL to the IDE in this example, but you can add multiple URLs by separating

them with commas. Copy and paste the link below into the Additional Boards Manager URLs option in the Arduino IDE preferences.

https://adafruit.github.io/arduino-board-index/package_adafruit_index.json

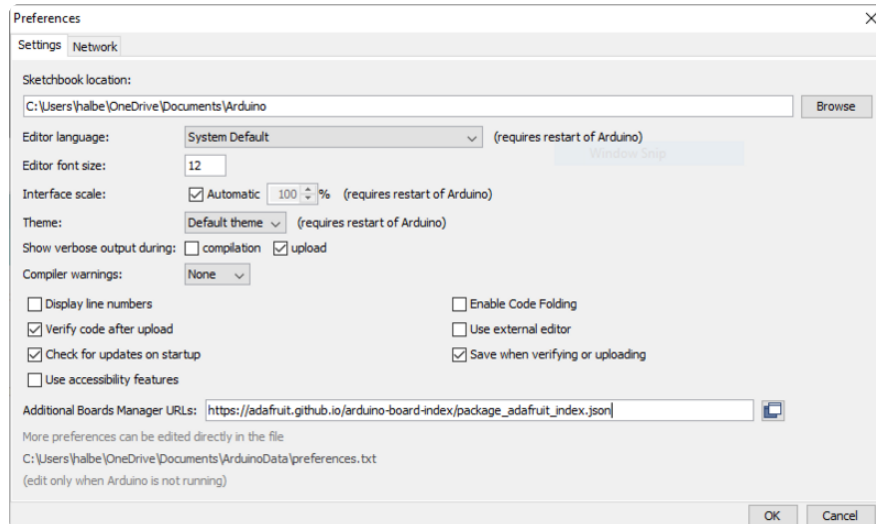

Here's a short description of each of the Adafruit supplied packages that will be available in the Board Manager when you add the URL:

- Adafruit AVR Boards - Includes support for Flora, Gemma, Feather 32u4, ItsyBitsy 32u4, Trinket, & Trinket Pro.
- Adafruit SAMD Boards - Includes support for Feather M0 and M4, Metro M0 and M4, ItsyBitsy M0 and M4, Circuit Playground Express, Gemma M0 and Trinket M0
- Arduino Leonardo & Micro MIDI-USB - This adds MIDI over USB support for the Flora, Feather 32u4, Micro and Leonardo using the [arcore project \(https://adafru.it/eSI\)](https://adafru.it/eSI).

If you have multiple boards you want to support, say ESP8266 and Adafruit, have both URLs in the text box separated by a comma (,)

Once done click OK to save the new preference settings. Next we will look at installing boards with the Board Manager.

Now continue to the next step to actually install the board support package!

Using with Arduino IDE

The Feather/Metro/Gemma/QTPy/Trinket M0 and M4 use an ATSAM21 or ATSAM51 chip, and you can pretty easily get it working with the Arduino IDE. Most libraries (including the popular ones like NeoPixels and display) will work with the M0 and M4, especially devices & sensors that use I2C or SPI.

Now that you have added the appropriate URLs to the Arduino IDE preferences in the previous page, you can open the Boards Manager by navigating to the Tools->Board menu.

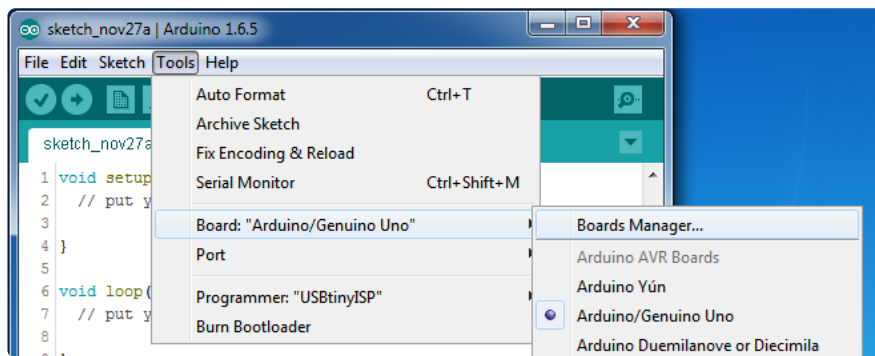

Once the Board Manager opens, click on the category drop down menu on the top left hand side of the window and select All. You will then be able to select and install the boards supplied by the URLs added to the preferences.

Remember you need SETUP the Arduino IDE to support our board packages - see the previous page on how to add adafruit's URL to the preferences

Install SAMD Support

First up, install the latest Arduino SAMD Boards (version 1.6.11 or later)

You can type Arduino SAMD in the top search bar, then when you see the entry, click I nstall

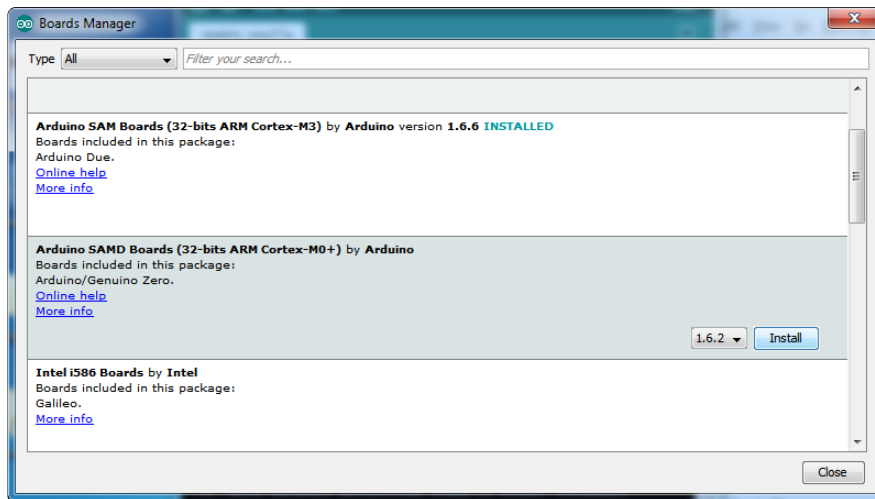

Install Adafruit SAMD

Next you can install the Adafruit SAMD package to add the board file definitions

Make sure you have Type All selected to the left of the Filter your search... box

You can type Adafruit SAMD in the top search bar, then when you see the entry, click Install

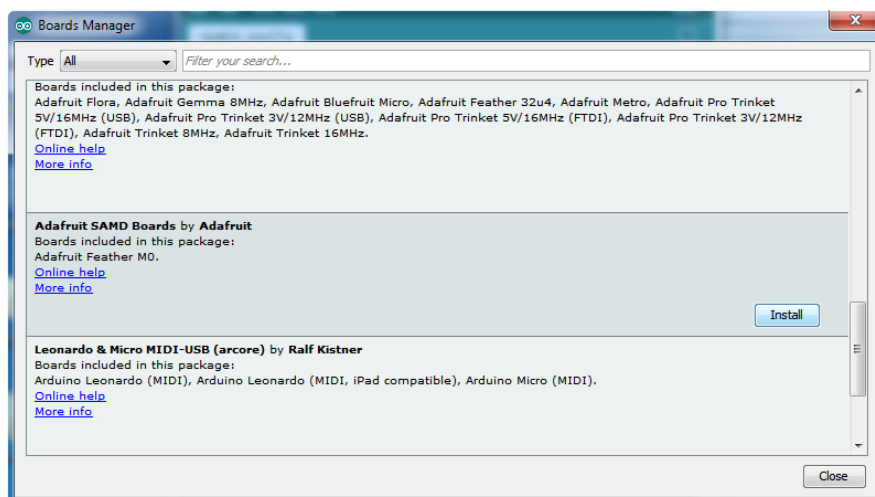

Even though in theory you don't need to - I recommend rebooting the IDE

Quit and reopen the Arduino IDE to ensure that all of the boards are properly installed. You should now be able to select and upload to the new boards listed in the Tools->Board menu.

Select the matching board, the current options are:

- Feather M0 (for use with any Feather M0 other than the Express)
- Feather M0 Express
- Metro M0 Express
- Circuit Playground Express
- Gemma M0
- Trinket M0
- QT Py M0
- ItsyBitsy M0
- Hallowing M0
- Crickit M0 (this is for direct programming of the Crickit, which is probably not what you want! For advanced hacking only)
- Metro M4 Express
- Grand Central M4 Express
- ItsyBitsy M4 Express
- Feather M4 Express
- Trellis M4 Express
- PyPortal M4
- PyPortal M4 Titano
- PyBadge M4 Express
- Metro M4 Airlift Lite
- PyGamer M4 Express
- MONSTER M4SK
- Hallowing M4
- MatrixPortal M4
- BLM Badge

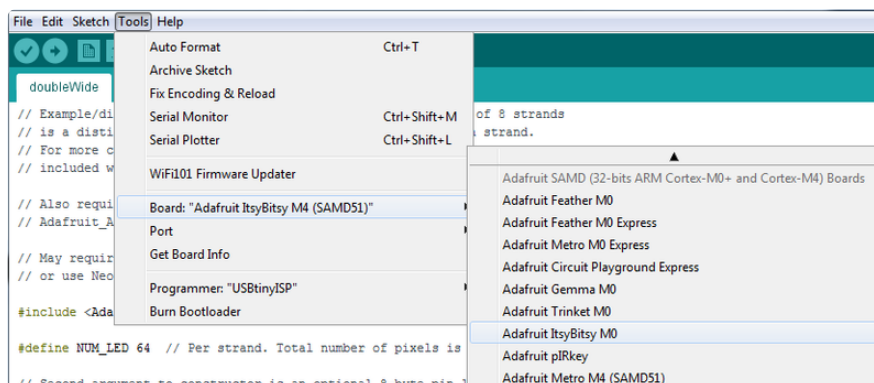

Install Drivers (Windows 7 & 8 Only)

When you plug in the board, you'll need to possibly install a driver

Click below to download our Driver Installer

Download Latest Adafruit Drivers
package

<https://adafru.it/mb8>

Download and run the installer

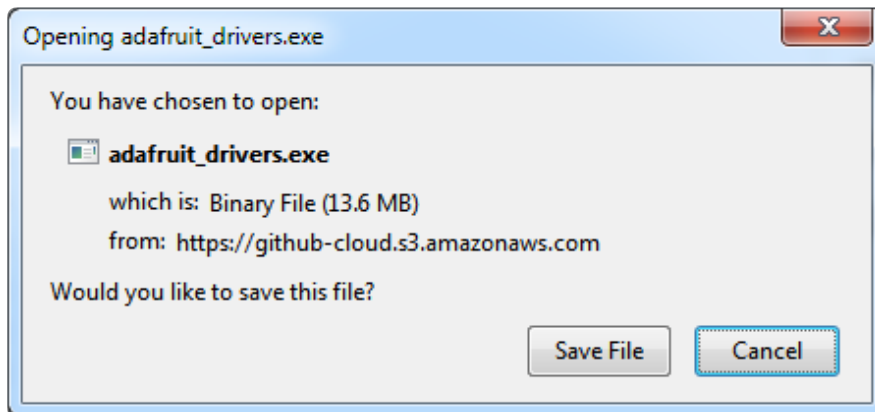

Run the installer! Since we bundle the SiLabs and FTDI drivers as well, you'll need to click through the license

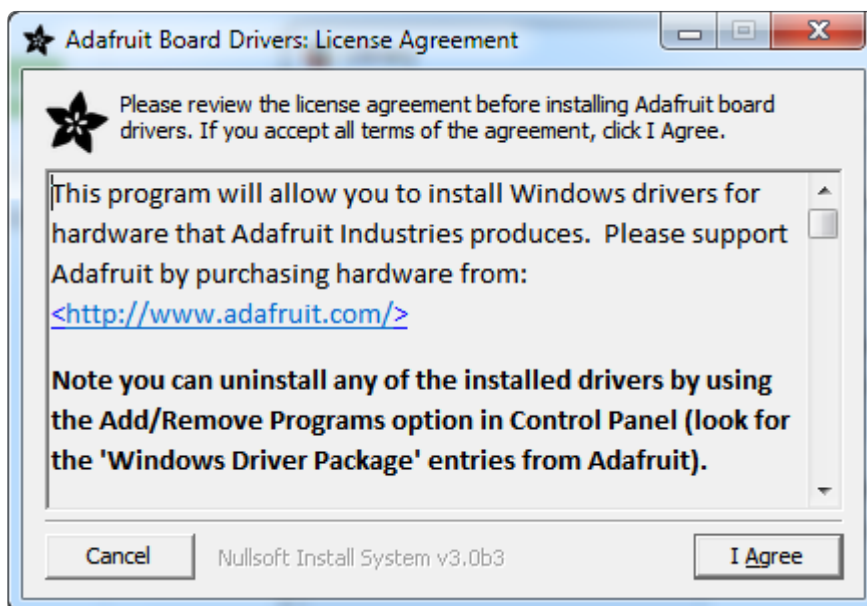

Select which drivers you want to install, the defaults will set you up with just about every Adafruit board!

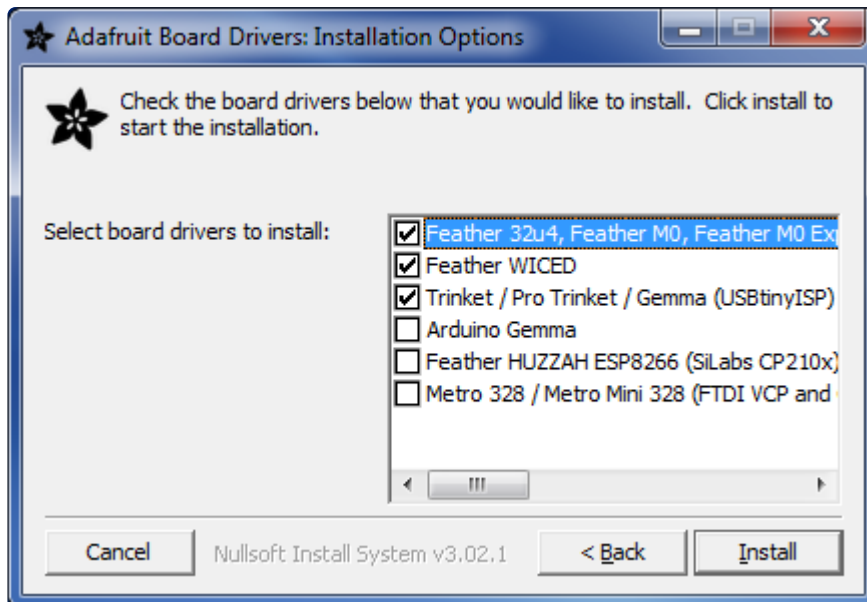

Click Install to do the installin'

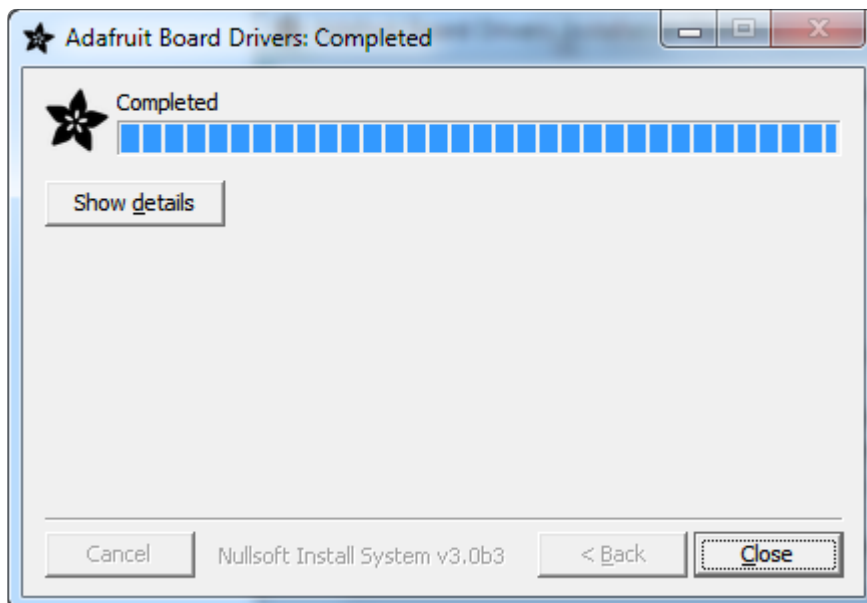

Blink

Now you can upload your first blink sketch!

Plug in the M0 or M4 board, and wait for it to be recognized by the OS (just takes a few seconds). It will create a serial/COM port, you can now select it from the drop-down, it'll even be 'indicated' as Trinket/Gemma/Metro/Feather/ItsyBitsy/Trellis!

Please note, the QT Py and Trellis M4 Express are two of our very few boards that does not have an onboard pin 13 LED so you can follow this section to practice uploading but you wont see an LED blink!

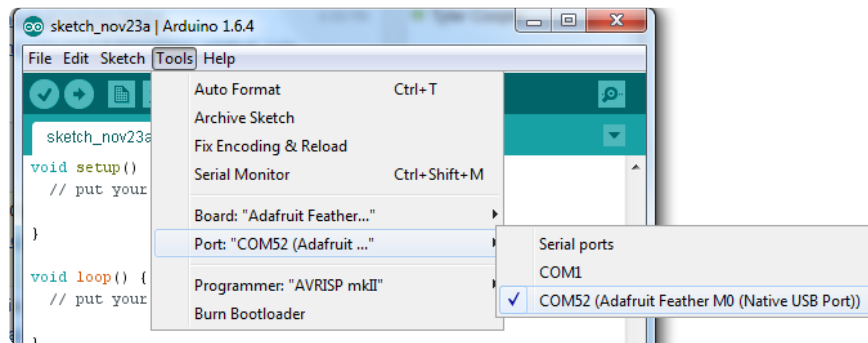

Now load up the Blink example

```
// the setup function runs once when you press reset or power the board
void setup() {
  // initialize digital pin 13 as an output.
  pinMode(13, OUTPUT);
}

// the loop function runs over and over again forever
void loop() {
  digitalWrite(13, HIGH);    // turn the LED on (HIGH is the voltage level)
  delay(1000);              // wait for a second
  digitalWrite(13, LOW);   // turn the LED off by making the voltage LOW
  delay(1000);              // wait for a second
}
```

And click upload! That's it, you will be able to see the LED blink rate change as you adapt the delay() calls.

If you are having issues, make sure you selected the matching Board in the menu that matches the hardware you have in your hand.

Successful Upload

If you have a successful upload, you'll get a bunch of red text that tells you that the device was found and it was programmed, verified & reset

```
Done uploading.
Write 11024 bytes to flash (173 pages)

[=====          ] 36% (64/173 pages)
[=====          ] 73% (128/173 pages)
[=====          ] 100% (173/173 pages)

done in 0.097 seconds

Verify 11024 bytes of flash with checksum.

Verify successful

done in 0.049 seconds

CPU reset.
```

6 Adafruit Feather M0 (Native USB Port) on COM54

After uploading, you may see a message saying "Disk Not Ejected Properly" about the ...BOOT drive. You can ignore that message: it's an artifact of how the bootloader and uploading work.

Compilation Issues

If you get an alert that looks like

Cannot run program "{runtime.tools.arm-none-eabi-gcc.path}\bin\arm-non-eabi-g++"

Make sure you have installed the Arduino SAMD boards package, you need both Arduino & Adafruit SAMD board packages

```
Cannot run program "{runtime.tools.arm-none-eabi-gcc.path}\bin\arm-non-eabi-g++" Copy error messages

{runtime.tools.arm-none-eabi-gcc.path}/bin/arm-none-eabi-g++ -mcpu=cortex-m0plus -mth
max-inline-insns-single=500 -fno-rtti -fno-exceptions -MMD -DF_CPU=48000000L -DARDUIN
-DUSB_MANUFACTURER="Adafruit" -DUSB_PRODUCT="Feather M0" -I{runtime.tools.CMSIS.path}
-IC:\Users\ladyada\AppData\Roaming\Arduino15\packages\adafruit\hardware\samd\1.0.2\co
-IC:\Users\ladyada\AppData\Roaming\Arduino15\packages\adafruit\hardware\samd\1.0.2\va
-IC:\Users\ladyada\AppData\Roaming\Arduino15\packages\adafruit\hardware\samd\1.0.2\li
-IC:\Users\ladyada\Dropbox\ArduinoSketches\libraries\WINC1500\src C:\Users\ladyada\Ap
C:\Users\ladyada\AppData\Local\Temp\build5777565695508348365.tmp\mqtt_winc1500.cpp.o

Cannot run program "{runtime.tools.arm-none-eabi-gcc.path}\bin\arm-non-eabi-g++" (in
```

1 Adafruit Feather M0 (Native USB Port) on COM11

Manually bootloading

If you ever get in a 'weird' spot with the bootloader, or you have uploaded code that crashes and doesn't auto-reboot into the bootloader, click the RST button twice (like a double-click) to get back into the bootloader.

The red LED will pulse and/or RGB LED will be green, so you know that its in bootloader mode.

Once it is in bootloader mode, you can select the newly created COM/Serial port and re-try uploading.

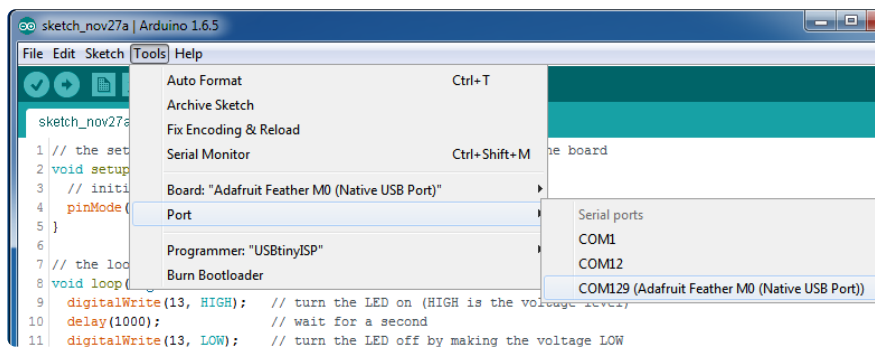

You may need to go back and reselect the 'normal' USB serial port next time you want to use the normal upload.

Ubuntu & Linux Issue Fix

[Follow the steps for installing Adafruit's udev rules on this page. \(https://adafru.it/iOE\)](https://adafru.it/iOE)

Arduino Libraries

OK now that you have Arduino IDE set up, drivers installed if necessary and you've practiced uploading code, you can start installing all the Libraries we'll be using to program it.

There's a lot of libraries!

Install Libraries

Open up the library manager...

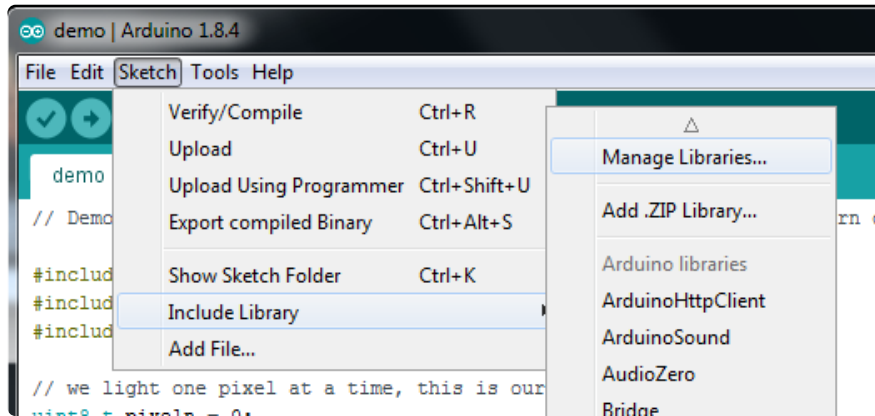

And install the following libraries:

Adafruit NeoPixel

This will let you light up the status LED on the back

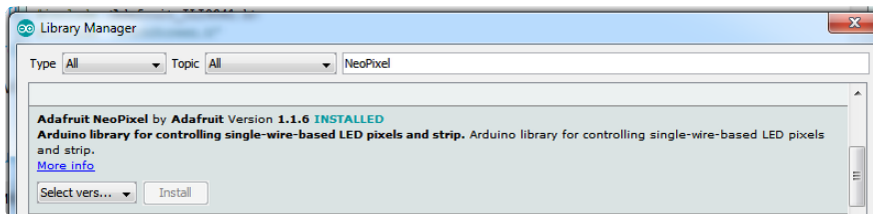

Adafruit SPIFlash

This will let you read/write to the onboard FLASH memory with super-fast QSPI support



Adafruit Zero DMA

This is used by the Graphics Library if you choose to use DMA

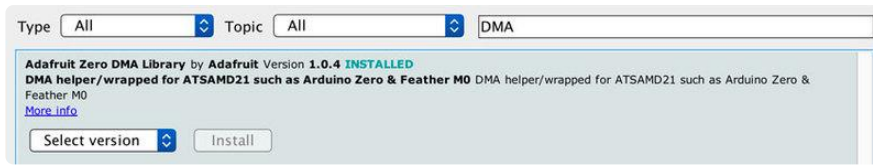

Adafuit GFX

This is the graphics library used to draw to the screen

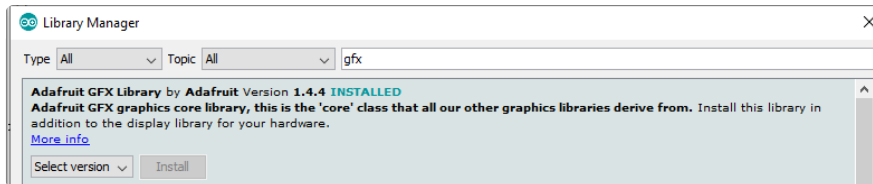

If using an older (pre-1.8.10) Arduino IDE, locate and install Adafuit_BusIO (newer versions do this automatically when installing Adafuit_GFX).

Adafuit ILI9341

The display on the PyPortal!

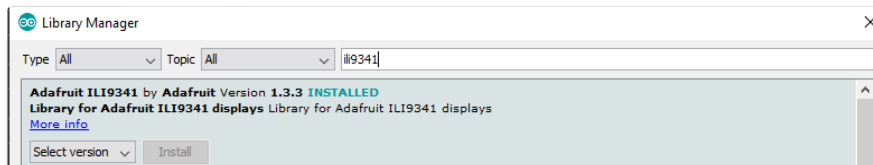

Adafuit HX8357

The display on the PyPortal Titano!

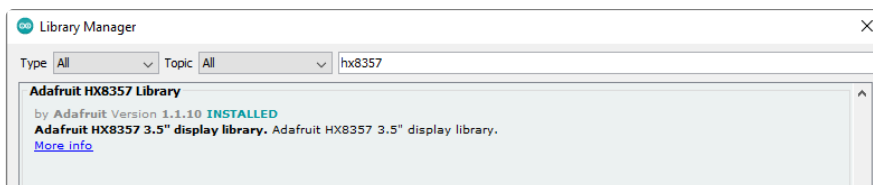

Adafuit Touchscreen

For reading touchscreen points on the resistive touchscreen

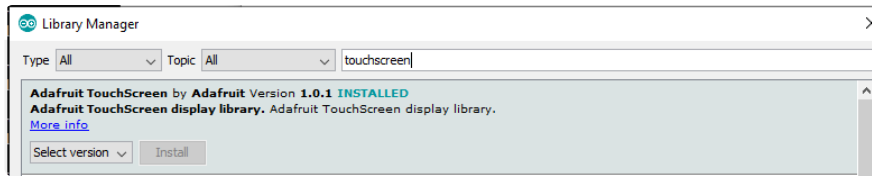

Analog Devices ADT7410

For reading temperature data from the onboard ADT7410

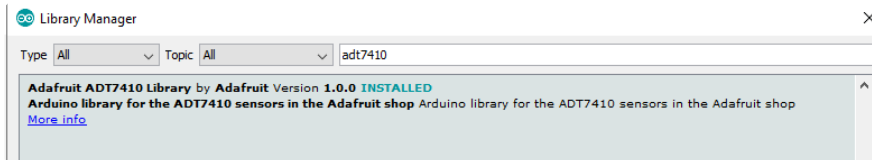

WiFiNINA

Will talk to the ESP32 WiFi co-processor to connect to the internet!

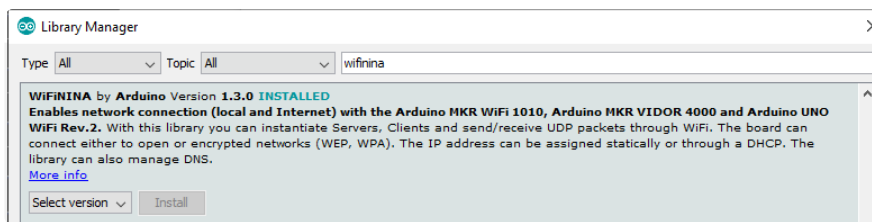

Adafruit ImageReader

For reading bitmaps from SD and displaying

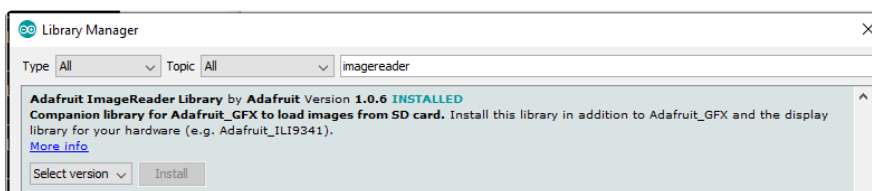

Arduino Test

Once you've got the IDE installed and libraries in place you can run our test sketch. This will check all the hardware, and display it on the screen, its sort of a universal test because every part is checked. It's also a great reference if you want to know how to read the light sensor or initialize the touch screen.

It's normal to get `SD Card...Failed` if there is no SD card in the socket.

The light sensor value ranges from 0 (dark) to 1023 (bright)

The temperature sensor will heat up if the backlight is on for a while, that's also normal! To avoid self-heating turn or or lower down the backlight brightness

`D3` and `D4` measure the analog voltages on the 3 pin JST connectors. They'll be floating until some voltage is applied to them.

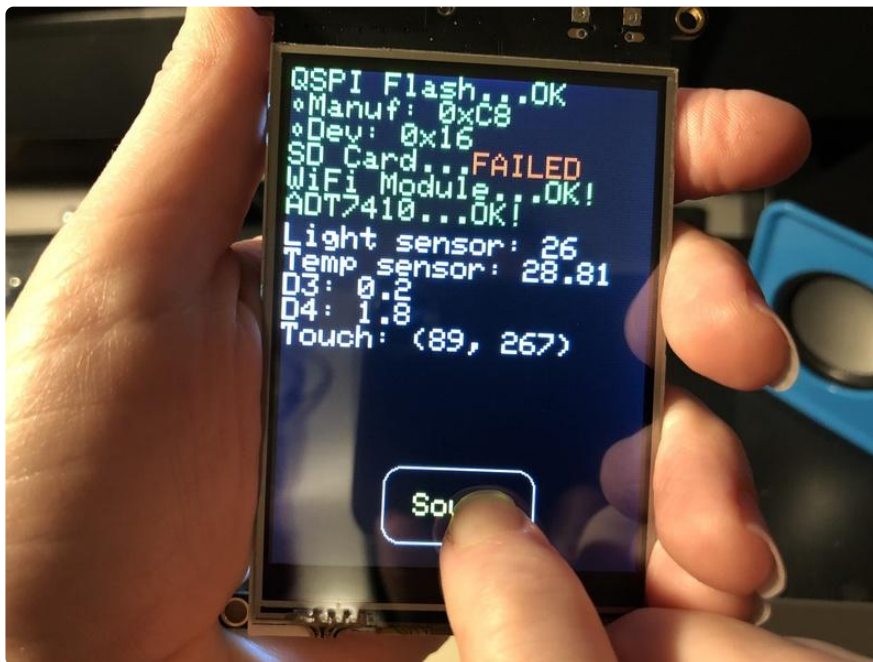

You can download the ready-to-go UF2 file and drag it onto the bootloader drive. To enter the bootloader, double click the reset button.

PyPortal_Titano_Self_Test.UF2

<https://adafru.it/XRf>

Click the Download Project Bundle button below to ensure you get both the Arduino program and the associated coin.h audio file!

```
// SPDX-FileCopyrightText: 2019 Limor Fried for Adafruit Industries
//
// SPDX-License-Identifier: MIT

// This program does a test of all the hardware so you can get an example of how to
read
// sensors, touchscreen, and display stuff!

#include "SPI.h"
#include "Adafruit_GFX.h"
#include "Adafruit_ILI9341.h"
```

```

#include <Adafruit_SPIFlash.h>
#include "Adafruit_ADT7410.h"
#include "TouchScreen.h"
#include <SdFat.h>
#include <Wi-Fi-NINA.h>
#include "coin.h"

#define RED_LED      13
#define TFT_RESET    24
#define TFT_BACKLIGHT 25
#define LIGHT_SENSOR A2
#define SD_CS        32
#define SPKR_SHUTDOWN 50

#define TFT_D0       34 // Data bit 0 pin (MUST be on PORT byte boundary)
#define TFT_WR       26 // Write-strobe pin (CCL-inverted timer output)
#define TFT_DC       10 // Data/command pin
#define TFT_CS       11 // Chip-select pin
#define TFT_RST      24 // Reset pin
#define TFT_RD       9  // Read-strobe pin
#define TFT_BACKLIGHT 25
// ILI9341 with 8-bit parallel interface:
Adafruit_ILI9341 tft = Adafruit_ILI9341(tft8bitbus, TFT_D0, TFT_WR, TFT_DC, TFT_CS,
TFT_RST, TFT_RD);

Adafruit_FlashTransport_QSPI flashTransport(PIN_QSPI_SCK, PIN_QSPI_CS, PIN_QSPI_I00,
PIN_QSPI_I01, PIN_QSPI_I02, PIN_QSPI_I03);
Adafruit_SPIFlash flash(&flashTransport);

Adafruit_ADT7410 tempSensor = Adafruit_ADT7410();

#define YP A4 // must be an analog pin, use "An" notation!
#define XM A7 // must be an analog pin, use "An" notation!
#define YM A6 // can be a digital pin
#define XP A5 // can be a digital pin
TouchScreen ts = TouchScreen(XP, YP, XM, YM, 300);
#define X_MIN 750
#define X_MAX 325
#define Y_MIN 840
#define Y_MAX 240

Adafruit_GFX_Button coin = Adafruit_GFX_Button();
SdFat SD;

void setup() {
  Serial.begin(115200);
  //while (!Serial);

  Serial.println("All Test!");

  pinMode(RED_LED, OUTPUT);
  pinMode(TFT_BACKLIGHT, OUTPUT);
  digitalWrite(TFT_BACKLIGHT, HIGH);

  pinMode(TFT_RESET, OUTPUT);
  digitalWrite(TFT_RESET, HIGH);
  delay(10);
  digitalWrite(TFT_RESET, LOW);
  delay(10);
  digitalWrite(TFT_RESET, HIGH);
  delay(10);

  tft.begin();

  tft.fillScreen(ILI9341_BLACK);
  tft.setTextSize(2);
  tft.setTextColor(ILI9341_GREEN);
  tft.setTextWrap(true);
  tft.setCursor(0, 0);

```

```

tft.print("QSPI Flash...");
if (!flash.begin()){
  Serial.println("Could not find flash on QSPI bus!");
  tft.setTextColor(ILI9341_RED);
  tft.println("FAILED");
  while (1);
}
Serial.println("Reading QSPI ID");
Serial.print("JEDEC ID: 0x"); Serial.println(flash.getJEDECID(), HEX);
tft.setTextColor(ILI9341_GREEN);
tft.print("QSPI Flash JEDEC 0x"); tft.println(flash.getJEDECID(), HEX);

/***** SD CARD */
tft.setCursor(0, 48);
tft.print("SD Card...");
if (!SD.begin(SD_CS)) {
  Serial.println("Card init. failed!");
  tft.setTextColor(ILI9341_RED);
  tft.println("FAILED");
  tft.setTextColor(ILI9341_GREEN);
} else {
  tft.println("OK!");
}

/***** WiFi Module */

tft.setCursor(0, 64);
tft.print("WiFi Module...");
WiFi.status();
delay(100);
if (WiFi.status() == WL_NO_MODULE) {
  Serial.println("ESP32 SPI not found");
  tft.setTextColor(ILI9341_RED);
  tft.println("FAILED");
  tft.setTextColor(ILI9341_GREEN);
} else {
  Serial.println("ESP32 SPI mode found");
  tft.println("OK!");
}

/***** Temperature sensor */
tft.setCursor(0, 80);
tft.print("ADT7410...");
if (!tempSensor.begin()) {
  Serial.println("Couldn't find ADT7410!");
  tft.setTextColor(ILI9341_RED);
  tft.println("FAILED");
  tft.setTextColor(ILI9341_GREEN);
} else {
  Serial.println("ADT7410 found");
  tft.println("OK!");
}

coin.initButton(&tft, 120, 280, 100, 50, ILI9341_WHITE, ILI9341_YELLOW,
ILI9341_BLACK, "Sound", 2);
coin.drawButton();

analogWriteResolution(12);
analogWrite(A0, 128);
pinMode(SPKR_SHUTDOWN, OUTPUT);
digitalWrite(SPKR_SHUTDOWN, LOW);
}

void loop() {
  digitalWrite(RED_LED, HIGH);
  tft.setTextColor(ILI9341_WHITE);
  // read light sensor
  tft.fillRect(160, 100, 240, 16, ILI9341_BLACK);

```



```

tft.setCursor(0, 100);
uint16_t light = analogRead(LIGHT_SENSOR);
Serial.print("light sensor: "); Serial.println(light);
tft.print("Light sensor: "); tft.println(light);

// read temp sensor
tft.fillRect(150, 116, 240, 16, ILI9341_BLACK);
tft.setCursor(0, 116);
float temp = tempsensor.readTempC();
Serial.print("temp sensor: "); Serial.println(temp, 2);
tft.print("Temp sensor: "); tft.println(temp, 2);

// externals
tft.fillRect(0, 132, 240, 32, ILI9341_BLACK);
tft.setCursor(0, 132);
float d3 = (float)analogRead(A1) * 3.3 / 1024;
float d4 = (float)analogRead(A3) * 3.3 / 1024;
Serial.print("STEMMA: ");
Serial.print(d3,1); Serial.print(", ");
Serial.print(d4,1); Serial.println();
tft.print("D3: "); tft.println(d3,1);
tft.print("D4: "); tft.println(d4,1);

tft.fillRect(80, 164, 240, 16, ILI9341_BLACK);
tft.setCursor(0, 164);
tft.print("Touch: ");

TSPoint p = ts.getPoint();
// we have some minimum pressure we consider 'valid'
// pressure of 0 means no pressing!
if (p.z > ts.pressureThreshold) {
  Serial.print("X = "); Serial.print(p.x);
  Serial.print("\tY = "); Serial.print(p.y);
  Serial.print("\tPressure = "); Serial.println(p.z);
  int16_t x = map(p.x, X_MIN, X_MAX, 0, 240);
  int16_t y = map(p.y, Y_MIN, Y_MAX, 0, 320);
  tft.print("("); tft.print(x); tft.print(", "); tft.print(y); tft.println(")");
  if (coin.contains(x, y)) {
    Serial.println("Ding!");
    coin.press(true);
  } else {
    coin.press(false);
  }
} else {
  coin.press(false);
}
if (coin.justPressed()) {
  coin.drawButton(true);
  digitalWrite(SPKR_SHUTDOWN, HIGH);

  uint32_t i, prior, usec = 1000000L / SAMPLE_RATE;
  prior = micros();
  for (uint32_t i=0; i<sizeof(coinaudio); i++) {
    uint32_t t;
    while((t = micros()) - prior < usec);
    analogWrite(A0, (uint16_t)coinaudio[i]);
    prior = t;
  }
  digitalWrite(SPKR_SHUTDOWN, LOW);
}
if (coin.justReleased()) {
  coin.drawButton(false);
}
digitalWrite(RED_LED, LOW);
delay(20);
}

```

Updating ESP32 Firmware

There may come a time when you want to update the firmware on the ESP32 itself. This isn't something we expect you'll do often if at all, but its good to know how if you need to.

[We have a guide here which details the process of updating the ESP32 firmware on Airlift All-in-One boards \(including the PyPortal, MatrixPortal, and Metro M4 AirLift\) here... \(https://adafru.it/FWs\)](https://adafru.it/FWs)

Parsing JSON

Parsing JSON from the Web

[Here an example of how you can display text data from the web with PyPortal, by making an internet-connected quote book. \(https://adafru.it/Hjb\)](https://adafru.it/Hjb)

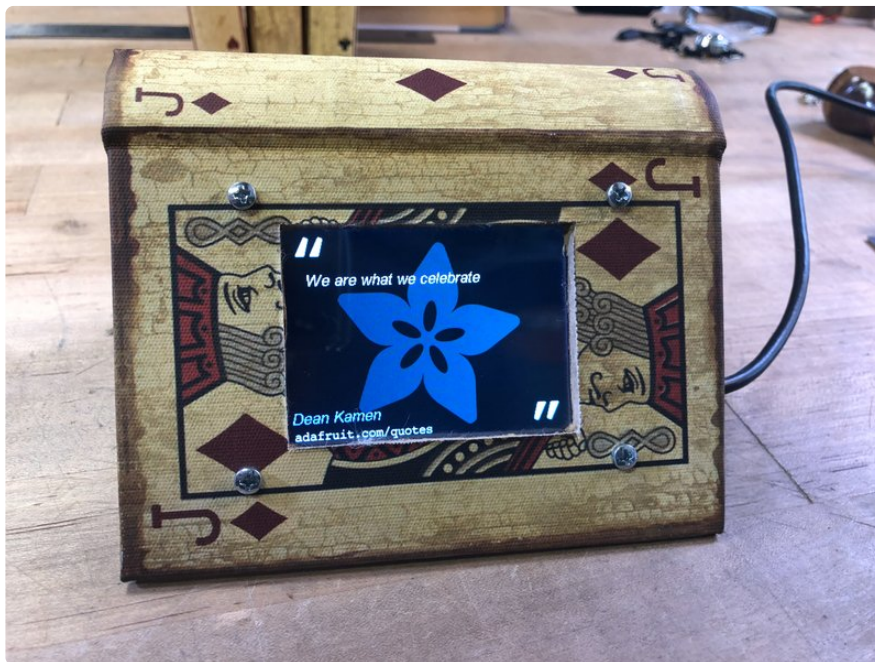

```
# SPDX-FileCopyrightText: 2019 Limor Fried for Adafruit Industries
#
# SPDX-License-Identifier: MIT

import time
import board
from adafruit_pyportal import PyPortal

# Set up where we'll be fetching data from
DATA_SOURCE = "https://www.adafruit.com/api/quotes.php"
QUOTE_LOCATION = [0, 'text']
AUTHOR_LOCATION = [0, 'author']
```

```

# the current working directory (where this file is)
cwd = ("/" + __file__).rsplit('/', 1)[0]
pyportal = PyPortal(url=DATA_SOURCE,
                    json_path=(QUOTE_LOCATION, AUTHOR_LOCATION),
                    status_neopixel=board.NEOPIXEL,
                    default_bg=cwd+"/quote_background.bmp",
                    text_font=cwd+"/fonts/Arial-ItalicMT-17.bdf",
                    text_position=((20, 120), # quote location
                                  (5, 210)), # author location
                    text_color=(0xFFFFFF, # quote text color
                                 0x8080FF), # author text color
                    text_wrap=(35, # characters to wrap for quote
                                0), # no wrap for author
                    text_maxlen=(180, 30), # max text size for quote & author
                    )

# speed up projects with lots of text by preloading the font!
pyportal.preload_font()

while True:
    try:
        value = pyportal.fetch()
        print("Response is", value)
    except (ValueError, RuntimeError) as e:
        print("Some error occurred, retrying! -", e)
        time.sleep(60)

```

JSON

The neat part is that the text is not coming from a file on the device (see how to do this next), but rather it is grabbed from a website!

Adafruit.com has a PHP script at the adafruit.com/api/quotes.php page. Each time it is requested, it returns a new quote from a large database of quotes.

In fact, you can run the same query the PyPortal does to see the results. Copy and paste this link: <https://www.adafruit.com/api/quotes.php>

into your browser and you'll see a result like this:

```

[
  {
    "text": "Science, my lad, is made up of mistakes, but they are mistakes which it is useful to make"
    "author": "Jules Verne"
  }
]

```

That result is the quote formatted as a JSON (JavaScript Object Notation) array. It is comprised of a single element with two keys: text and author.

- The value of the text key is `Science, my lad, is made up of mistakes, but they are mistakes which it is useful to make, because they lead little by little to the truth`
- The value of the author key is `Jules Verne`

Since this JSON object has a consistent way to return the results to us, the code we're running on the PyPortal can easily parse the data and display it!

You can see how it's done in this part of code.py:

```
# Set up where we'll be fetching data from
DATA_SOURCE = "https://www.adafruit.com/api/quotes.php"
QUOTE_LOCATION = [0, 'text']
AUTHOR_LOCATION = [0, 'author']
```

Then, in the `pyportal` query we ask for the text and author name from that URL, and then use the `text_` arguments to set the `font`, `position`, `color`, `wrap`, and `max len` of the text when it is displayed.

```
pyportal = PyPortal(url=DATA_SOURCE,
                    json_path=(QUOTE_LOCATION, AUTHOR_LOCATION),
                    status_neopixel=board.NEOPIXEL,
                    default_bg=cwd+"quote_background.bmp",
                    text_font=cwd+"fonts/Arial-ItalicMT-17.bdf",
                    text_position=((20, 40), # quote location
                                 (5, 190)), # author location
                    text_color=(0xFFFFFF, # quote text color
                                0x8080FF), # author text color
                    text_wrap=(35, # characters to wrap for quote
                               0), # no wrap for author
                    text_maxlen=(180, 30), # max text size for quote & author
                    )
```

With all of this prepared, during the main loop of `while True:` the code will query the Adafruit quotes page for the JSON data, and display it, and then wait one minute until repeating the process.

Parsing local JSON files

If you would like to avoid pulling data from a web page or maybe you can't get access to a specific API key, you can use a "local" JSON file to pull data from.

To implement this local data sourcing method, create a new file and name it `local.txt`. Populate this file with the JSON data that you would like to use. For example, you could use the JSON data provided above and make sure the format of the data is the same. Save this file on the CIRCUITPY drive in the root.

You should not need to change anything in your code.

And that's it! The JSON data will now be pulled from this local file!

PyPortal Hardware FAQ

For CircuitPython-specific issues, see the [CircuitPython software FAQ \(https://adafru.it/HOE\)](https://adafru.it/HOE).

The PyPortal screen is all white or blank when powered on.

In shipping, the connector for the display may pop the retention tab(s) (red circles below). If you see one that is not in the position below, check to see if the orange display ribbon cable is straight. If so, gently push the tab down towards the main connector.

If you see the ribbon cable crooked, pop both tabs and slide the cable gently so it is in the connector like the picture and straight. then clip each side down.

Repower the PyPortal afterwards and hopefully you'll see the CircuitPython boot text on the screen.

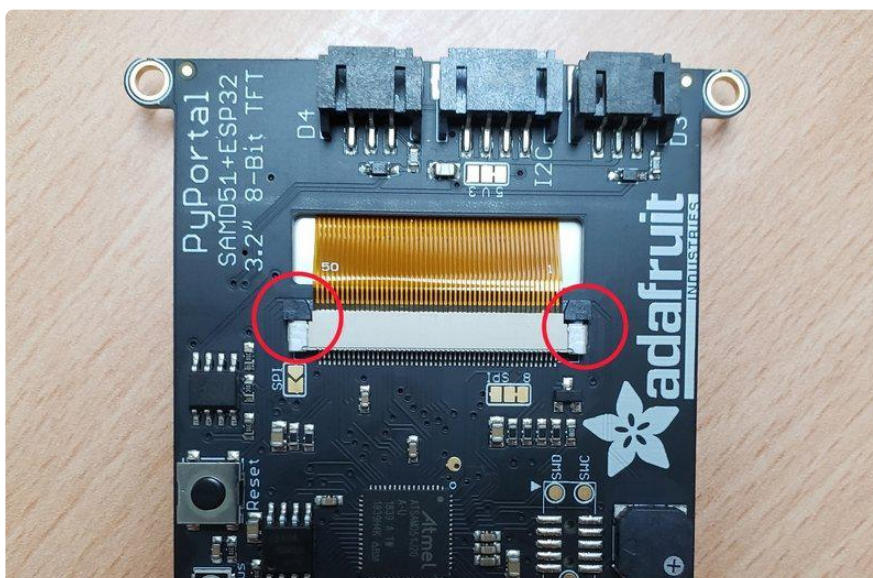

I'm using the STEMMA I2C connector to attach sensors and experiencing issues.

If you look at the pads circled in yellow below, there is a tiny connection between the V and 5 pads indicating a default of 5V power, which may cause issue in certain setups. If you are connecting one our sensors and seeing boot or other issues, try changing the voltage to 3.3V

If you want 3.3 volt power for your I2C connector, carefully cut that tiny trace between V and 5, then using a soldering iron connect the 3 and V pads. The PyPortal was not made to switch often between these two values so double check your I2C data sheets, some sensors can take 3.3 and 5V power so leaving it at 5 should be ok.

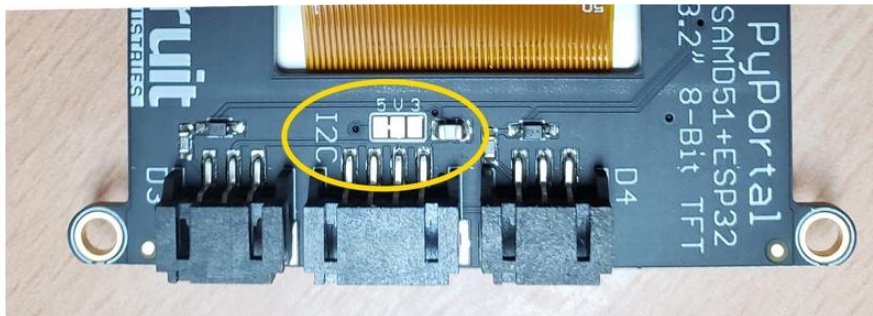

I'm seeing "AT" or other text being inserted at the REPL prompt.

If you're on Linux, and are seeing multi-second delays connecting to the serial console, or are seeing "AT" and other gibberish when you connect, then the modemmanager service might be interfering. Just remove it; it doesn't have much use unless you're still using dial-up modems. To remove, type this command at a shell:

```
sudo apt purge modemmanager
```

What does the status NeoPixel indicate once my code.py is running?

Once your PyPortal boots up and successfully loads your code.py or main.py, the status NeoPixel will turn green briefly. Then, the NeoPixel will show one of the following color codes to indicate the status of the WiFi connection/activity or file operations:

- Red = not connected to WiFi

- Blue = connected to WiFi
 - Yellow = fetching data
 - Blue = got data
 - Cyan = file opening
-

My PyPortal Pynt JST STEMMA sockets aren't working!

The PyPortal Pynt has the D3 and D4 sockets mislabeled, they should be swapped (to match the pyportal classic)

Downloads

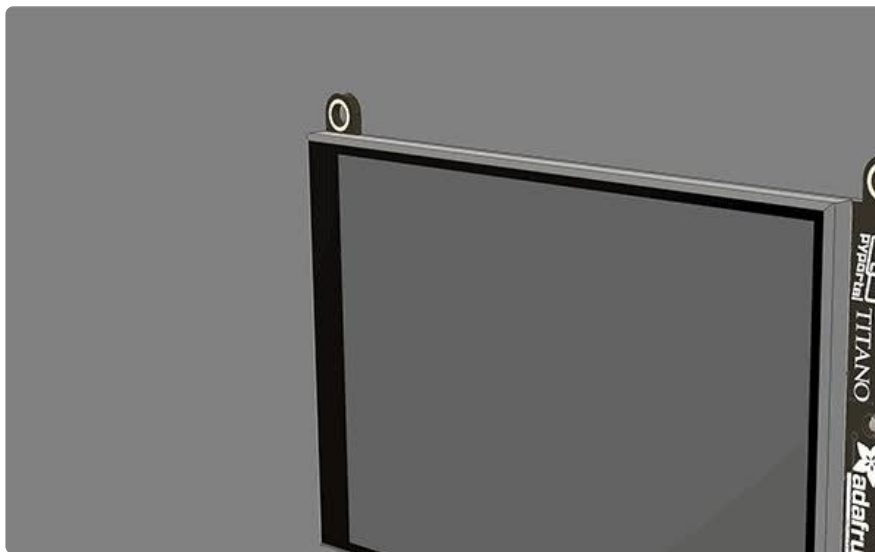

Files

- [ATSAMD51J20 datasheet \(https://adafru.it/E9c\)](https://adafru.it/E9c)
- [EagleCAD PCB files on GitHub \(https://adafru.it/E9d\)](https://adafru.it/E9d)
- [3D Models on GitHub \(https://adafru.it/HTB\)](https://adafru.it/HTB)
- [Fritzing object in Adafruit Fritzing Library \(https://adafru.it/HOF\)](https://adafru.it/HOF)
- [PDF for PyPortal Titano Board Diagram on GitHub \(https://adafru.it/-dW\)](https://adafru.it/-dW)

SVG for PyPortal Titano Board
Diagram

<https://adafru.it/-dX>

Schematic and Fab Print

